

HCM & HC Ejecto Water Systems Installation and Service Manual

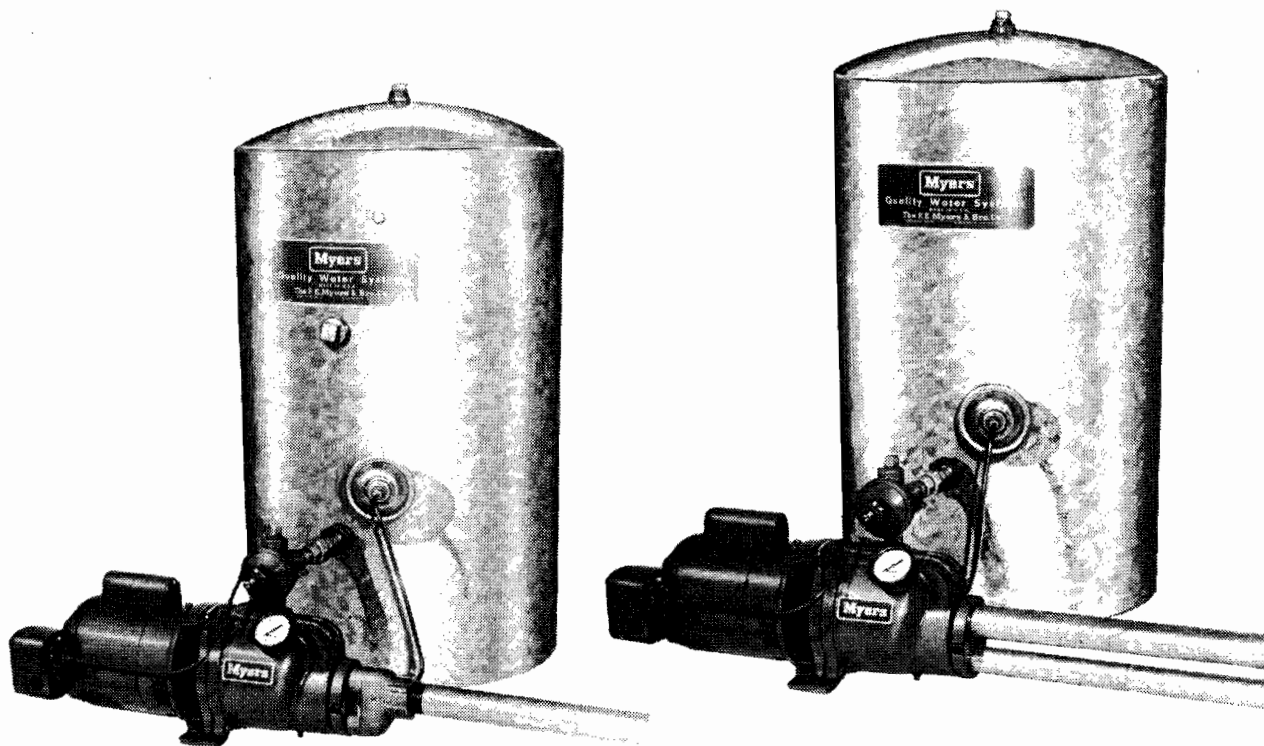

HCM & HC
Shallow Well

HCM & HC
Deepwell

Motor Grounding Instructions:

WARNING: Reduced risk of electric shock during operation of this pump requires the provision of acceptable grounding: **Caution: Failure to ground this unit properly may result in severe electrical shock.** If the means of connection to the supply-connection box is other than grounded metal conduit, ground the pump back to the service by connecting a copper conductor, at least the size of the circuit conductors supplying the pump, to the grounding screw provided within the wiring compartment. NOTE: National Electric Code requires pumps be grounded at installation.

Myers®

INSPECT THE SHIPMENT AND CHECK MATERIAL REQUIRED FOR INSTALLATION

Package Contents

1. Each pump is carefully tested and packed at the factory.
2. The catalog lists all parts included with package. A packing list packed with pump, also lists contents.
3. Be sure all parts have been furnished and that nothing has been damaged in shipment.
4. **OPEN PACKAGES AND MAKE THIS CHECK BEFORE GOING ON JOB.**

Color Coding On Pumps And Ejector Packages

1. All basic pump packages and ejector packages are color coded to make identification easy.
2. The color code is as follows:
 HCM Series Units are coded with **BLUE**.
 HC Series Units are coded with **GREEN**.

Ejector Package

1. Double check the ejector package to be sure it is specified for the pump being installed and that it is for the proper well lift. **ALL PACKAGES ARE CLEARLY MARKED WITH CATALOG NUMBER AND PUMP SIZE. DO NOT INTERCHANGE PACKAGES OR USE COMPETITIVE EJECTORS ON MYERS PUMPS OR GUARANTEE IS VOID.**

Material Check List

Use this material check as a reminder before starting on job.

Material Needed

1. **BASIC PUMP**—Does not include air control and tube—order separately if required. HC-HCM units include adapter fittings to connect any type plastic pipe to pump. HP units do not include any adapter fittings for pump.
2. **EJECTOR PACKAGE**—Ejector packages do not include (any) fittings to adapt ejector for plastic pipe. These must be supplied to suit plastic pipe being used.
3. **PRESSURE TANK**—21 Gal. and 42 Gal. tanks are tapped at correct height for pump piping and air control. 42 Gal. tanks and 82 Gal. tanks require bushings and plugs to connect pump. On 42 Gal. tall tank, Brady air control must be installed in the $\frac{3}{8}$ " tapping at a 17" height and on the 82 Gal. tank in the $\frac{3}{8}$ " tapping at a 20" height. All other holes are bushed or plugged. Use Air Volume Control on standard tank installation.
4. **PIPE**—Flexible plastic pipe, rigid plastic pipe or steel pipe of sufficient size and length for installation.
5. All fittings necessary to connect pipe to ejector and make surface connections.
6. Clamps for flexible plastic pipe, if used.
7. Cement for rigid plastic pipe, if used.
8. Well seal, if required.
9. Connecting pipe from pump to tank.
10. Electrical fused disconnect switch and wiring where required.
11. All necessary installation tools.

Installation Instructions HCM - HC SERIES Shallow Well

Ejector:

HCM Shallow Well

1. Short nipples, 4 to 6" long, must be attached to ejector body to properly space venturi tube from first impeller.
2. Nipples are sealed to case with rubber seal rings and clamp flange. (See Fig. 1). Use only ejector packages with Blue Labels. Do not use "B" or "C" ejectors. Use only ejectors specified for HCM.
3. HCM Series ejectors installed as shallow well units can be removed and placed in well if water level drops below suction lift limit of 25 ft.

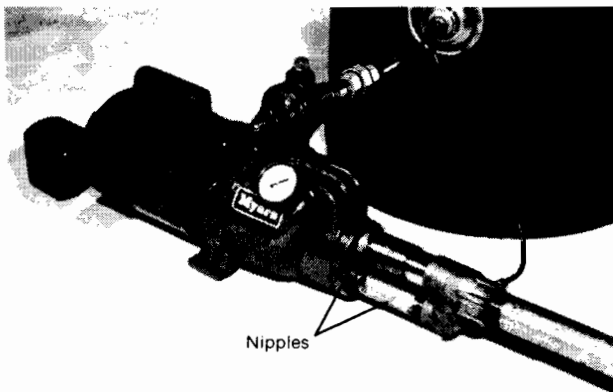

Figure 1

Foot Valve Or Check Valve:

HCM - HC Shallow Well

1. Foot valve must be used where well size will permit.

2. For small wells or drive point wells a check valve can be used at ground surface at well, either connected directly to drive well or to suction pipe installed in well.
3. $\frac{1}{4}$ " check valve or foot valve is used for all pump sizes.

Ejector:

HC Shallow Well

1. For shallow well operation, the ejector is attached directly to the pump case and is sealed with rubber seal rings and clamp flange.
2. With shallow well package only, a $2\frac{1}{2}$ " galvanized nipple, threaded one end, is supplied for connecting to ejector. Where a deep well package is used for shallow well service it will be necessary to make this nipple. If this nipple is wrench cut, file cuts smooth before installing rubber seal ring. (See Fig. 2). Use only **EJECTOR PACKAGES WITH GREEN LABELS**. Use only ejector packages specified for HC.
3. HC Series ejectors installed as shallow well units can be removed and placed in the well if water level drops below suction lift limit of 25 feet.

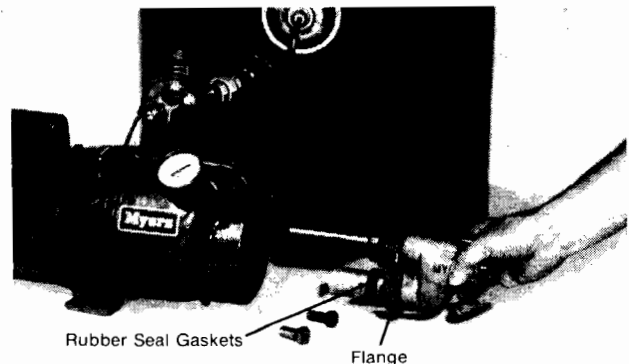

Figure 2

Suction Piping:

HCM - HC Shallow Well

1. Pump can be installed with steel, copper or plastic pipe.
2. Ejectors for HCM and HC are tapped for 1/4" suction pipe.
3. For off-set lines, pipe size should be increased to reduce friction.
4. Performance ratings are based on TOTAL SUCTION LIFT which is VERTICAL ELEVATION PLUS FRICTION.
5. For off-set installations horizontal suction lines must slope from pump to well without dips or high spots.

Connecting Pump To Tank:

HCM - HC Shallow Well

1. Galvanized steel pipe or rigid plastic pipe can be used to connect pump to tank.
2. Connect pump with union to tank.
3. Usually pump is not connected to tank until test is made on pump and well.

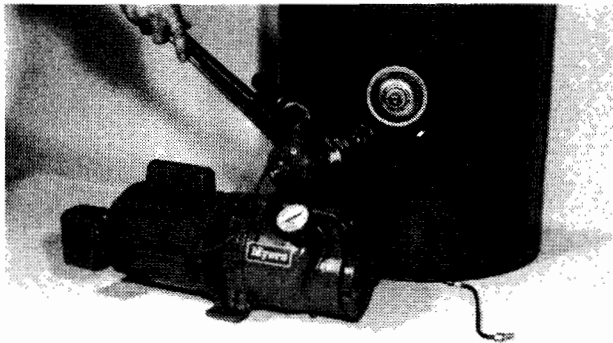

Figure 3

Connecting Air Volume Control:

HCM - HC Shallow Well

1. Remove 1/8" brass plug from ejector body and screw plug into 1/8" tapped opening in pump case suction.
2. Attach air control tube to 1/8" tapped opening in ejector suction. (See Fig. 4).

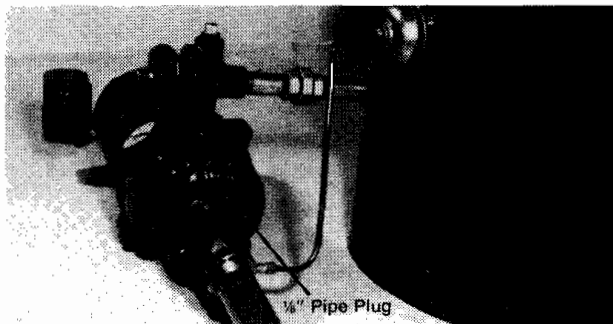

Figure 4

Electric Circuit:

HCM - HC Shallow Well

1. Either unit should be connected to a separate circuit, direct from main switch.
2. A fused disconnect switch or circuit breaker must be used in this circuit.
3. Plugging into existing outlets can cause low voltage at motor resulting in nuisance blowing of fuses or tripping of motor overload.

4. Motor must be wired for voltage being supplied. Name-plate of motor gives connecting diagrams.
5. All motors have built-in overload protection.

Priming Pump:

HCM - HC Shallow Well

1. Remove 1/2" pipe plug from pressure regulator body and fill piping and pump with water.
2. Replace plug, then start motor.
3. On suction lines using foot valve and no horizontal off-set, pump should prime and deliver water immediately.
4. On long off-set lines or drive point wells, pump may take several minutes to prime.
5. If pump does not prime in 5 or 6 minutes, stop motor, remove plug and add more water.

Operation:

HCM - HC Shallow Well

1. Allow pump to discharge into open long enough to find if well supply is adequate.
2. After performance is correct, connect pump to tank.
3. Allow pump to cycle automatically several times to check pressure switch setting and operation.

Installation Instructions HCM - HC SERIES Twin Type - Deep Well

Ejector:

HCM - HC Deep Well

1. For deep well service, ejector is installed in the well below pumping level.
2. Catalog ratings are based on ejector being installed 10 feet below pumping level.
3. If a tail pipe is used below the ejector, galvanized steel pipe can be used without the plastic nipple. Electrolytic corrosion is severe only when a short steel nipple is used between two brass castings.
4. For ejectors using 1/4" and 1/4" well pipes, make certain that delivery pipe (pipe fitting over venturi on ejector assembly) fits into top opening in pump case. Do not reverse pressure and delivery pipes or pump will not develop pressure.
5. USE ONLY EJECTOR PACKAGES SPECIFIED FOR HCM OR HC PUMPS. BLUE LABEL EJECTOR PACKAGES FOR HCM AND GREEN LABEL EJECTOR PACKAGES FOR HC. DO NOT USE COMPETITIVE EJECTORS WITH MYERS PUMP OR WARRANTY IS VOID.

Piping:

HCM - HC Deep Well

1. The HCM and HC are designed for easy connection to any type flexible or rigid plastic pipe and steel pipe without extra fittings.
2. Two special high strength plastic adapters are furnished with each pump for easy connection.
3. When flexible plastic pipe is used it is clamped to fittings and fittings are sealed to pump case with rubber seal rings and clamp flange. (See Figs. 5-6).

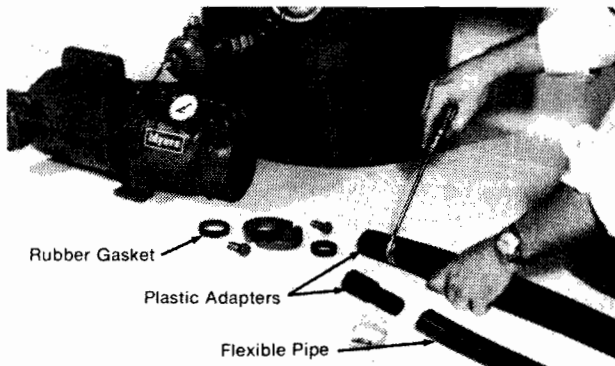

Figure 5

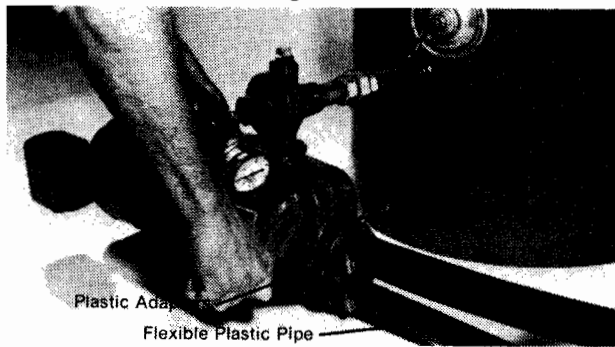

Figure 6

4. When rigid plastic pipe is used it is cemented to fittings with regular plastic pipe cement. Fittings are sealed to case with rubber rings and clamp flange. (See Figs. 7-8).

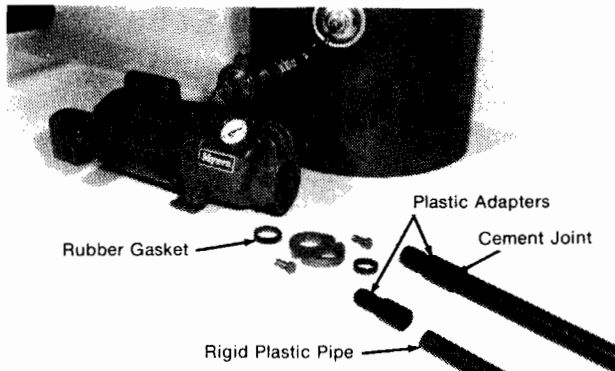

Figure 7



Figure 8

5. When steel pipe or rigid plastic pipe of same O.D. as steel pipe is used, it is sealed directly to pump case without fittings. (See Fig. 9).

6. For off-set installation, horizontal piping must slope from pump downward to well without dips or high spots.

7. Use only rigid plastic pipe or steel pipe on HCM pumps.

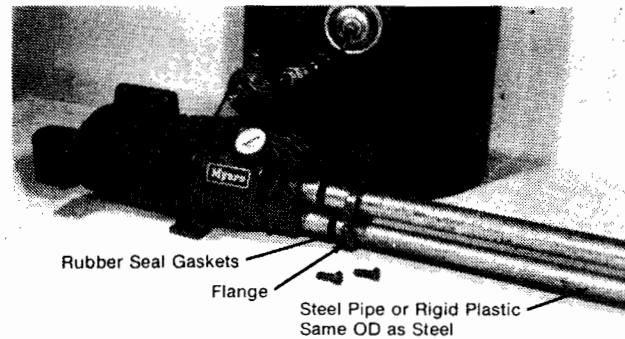

Figure 9

Connecting Air Control:

HCM - HC Deep Well

1. Air control tube is connected into $\frac{1}{8}$ " pipe tapping in pump case suction. (See Fig. 10).

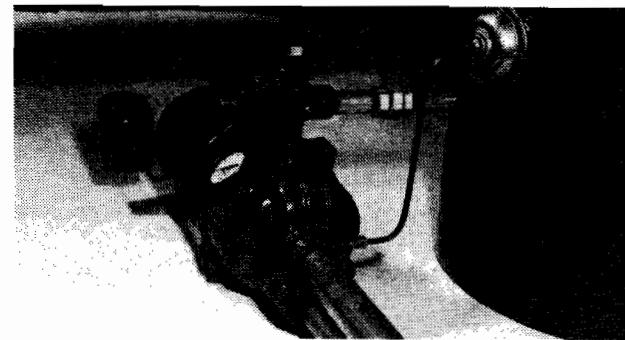

Figure 10

Electrical Circuit:

HCM - HC Deep Well

1. Use separate fused circuit for pump, same as specified under "HCM-HC Shallow Well Instructions."

Connecting Pump To Tank:

HCM - HC Deep Well

1. Steel pipe or rigid plastic pipe can be used to connect pump to tank.

2. Discharge pipe from pump to tank can be set at any angle by turning pressure regulator.

3. Usually pump is not connected to tank until it has been run to test the well and clear any sand or dirt that may flow with the first pumping.

Priming Pump And Setting Pressure Regulator Valve:

HCM-HC Deep Well

1. Remove $\frac{1}{2}$ " pipe plug from pressure regulator body and fill pump and piping with water.

2. Replace $\frac{1}{2}$ " plug, screw down tight on regulator adjusting screw and start motor.

3. If pump is properly primed, a high pressure will immediately show on gauge.

4. If no pressure is obtained, stop motor, remove $\frac{1}{2}$ " pipe plug and add more water to case.

5. With pump operating at high pressure, slowly unscrew regulator adjusting screw until maximum flow is obtained without pressure dropping to zero.

6. If pressure does drop completely, again screw down tight on adjusting screw and readjust until steady operation is obtained.

7. THIS STEADY PRESSURE WILL BE AVERAGE OPERATING PRESSURE AND SHOULD AGREE CLOSELY WITH THE PRESSURE SHOWN IN THE OLYMPIAN CATALOG. This value varies depending on pump size and type.

8. Allow pump to discharge into open long enough to clear the well of any sand or dirt and to be sure well is not going to pump down.
9. If well does draw down and break prime, it will be necessary to lower the ejector deeper into the well or change to a smaller pump.
10. Pump operating pressure should not be increased to reduce pump capacity as air control will not function properly. This is explained more fully in paragraph 13.
11. Allow pump to start and stop several times on automatic operation.
12. Notice pump pressure at instant pump starts. If pressure is more than 3 lbs. above average operating pressure, regulator adjusting screw should be unscrewed until pressure is within this range at the instant pump starts. Cycle pump several times to be sure of this set pressure.
13. Tighten locknut on regulator adjusting screw to maintain correct operating pressure setting.
14. IF PRESSURE IS TOO HIGH AT INSTANT PUMP STARTS, VACUUM WILL NOT EXIST AT PUMP SUCTION AND AIR CONTROL WILL NOT OPERATE. THIS IS IMPORTANT FOR SATISFACTORY AUTOMATIC OPERATION.
15. Check all pipe plugs and connections on pressure tank above water line for air leaks. Use soapsuds. NEVER LEAVE AN INSTALLATION WITHOUT MAKING THIS CHECK.

Packer

Installation Instructions

HCM - HC DEEP WELL

2" - 2½" - 3" Wells

Piping:

HCM - HC Packer

1. All packer ejectors for 2" well use 1" inner pipe.
2. All packer ejectors for 2½"-3" wells use 1½" inner pipe.
3. NO TURNED COUPLINGS ARE USED FOR EITHER 1" or 1½" PIPE.
4. Use only galvanized pipe or heavy rigid plastic pipe for inner pipe.

Ejector:

HCM - HC Packer

1. Connect all bronze ejector with cup packers to inner pipe and lower into well.
 2. Last length of inner pipe is screwed to well adapter.
 3. Well adapter is sealed to well with rubber ring and clamp flange.
- USE ONLY EJECTOR PACKAGES WITH BLUE LABELS ON HCM UNITS AND GREEN LABELS ON HC UNITS.

Connecting Air Control:

HCM - HC Packer

1. Air control tube is connected into ½" pipe tapping in pump case suction. (See Fig. 10).

Connecting Pump To Well:

HCM - HC Packer

1. Flexible plastic, rigid plastic or steel pipe can be used to connect pump to well adapter.
2. For close hook-up to well, steel pipe or rigid pipe nipple gives the simplest connection. (See Fig. 11).

3. For off-set installation, piping must slope from pump to well without dips or high spots. Piping is connected to pump case the same as shown for HCM-HC twin type deep well installation. All other installation instructions same as for HCM-HC twin type deep well units.

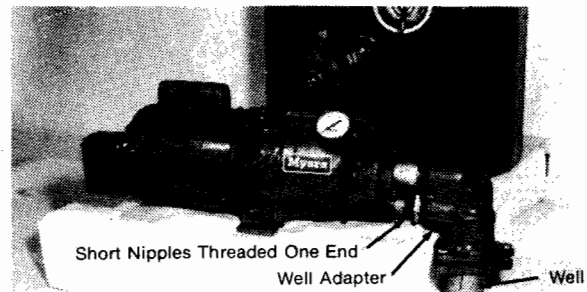

Figure 11

General Servicing Instructions

HCM - HC

Replacing Mechanical Seal:

HCM - HC

1. The seal used on all HCM and HC units is ¾" size.
2. This seal is made in two parts.
 - (a) Synthetic rubber bellows, stainless steel spring, drive ferrule with rubber ring and carbon seal ring.
 - (b) Stationary ceramic seal ring mounted in synthetic rubber cup.
3. Always replace both bellows and stationary ceramic seat. DO NOT USE OLD STATIONARY SEAT WITH NEW BELLOWS SEAL.
4. Old ceramic ring can be removed from housing by cracking with a chisel or screw without removing the pump shaft.
5. Housing and shaft must be clean and free of sand and dirt before replacing new seal. Wash parts with clean water.
6. Place stationary ceramic seat into housing. Press in with fingers only.
7. Place bellows unit on shaft, carbon ring toward ceramic seat, and press into position with fingers.
8. Do not use oil on seal faces as oil picks up dirt particles. Dirt on seal faces can cause failure.

How To Dismantle:

HCM

1. All pump parts can be removed from case without disturbing piping.
2. Remove case bolts and pry bracket from pump.
3. Remove 3 bolts from diffuser housing. (See Fig. 12).
4. Tighten two back-off screws to force housing from first stage diffuser. Work alternately on screws to force evenly without binding. (See Fig. 12).

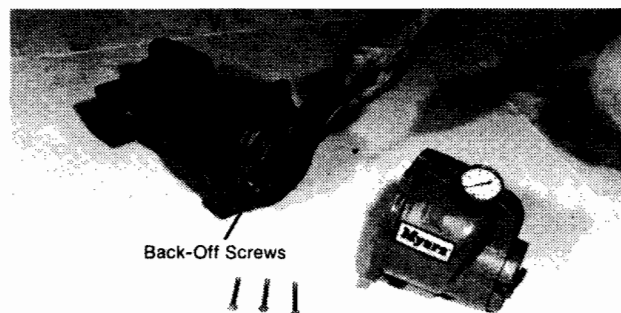

Figure 12

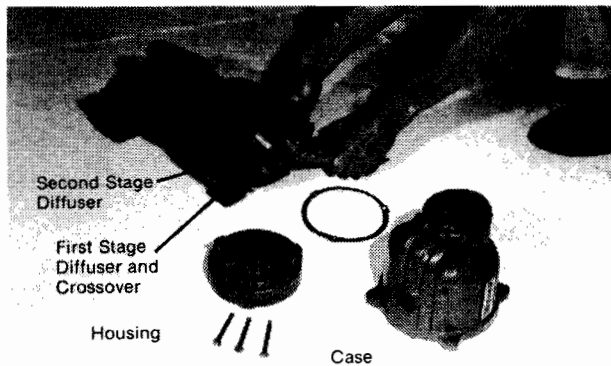

Figure 13

5. Hold pump shaft and unscrew first impeller. (RIGHT HAND THREAD—CCW FACING IMPELLER TO REMOVE.)
6. Remove first stage diffuser vane plate.
7. Hold pump shaft and unscrew second impeller. Use pliers, if necessary. File any plier cuts smooth on impeller eye surface. (RIGHT HAND THREAD—CCW FACING IMPELLER TO REMOVE). (See Fig. 13).

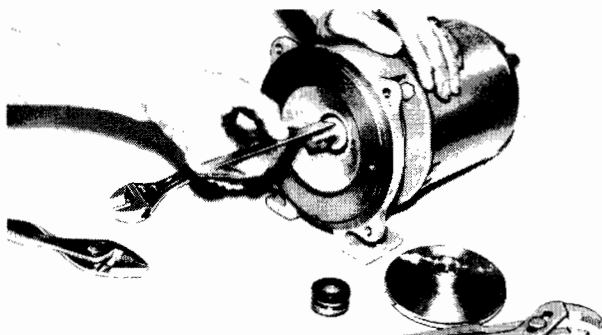

Figure 14

8. Seal can now be removed, if necessary.
9. If motor must be replaced, set shaft for seal spacing of 23/32" from seal seat face to shank on shaft. (See Fig. 14).
10. When replacing housing casting always use new gasket between housing and first diffuser vane plate. (See Fig. 15). Be sure holding pin in housing is correctly set to go between vane. This pin prevents diffuser from turning.

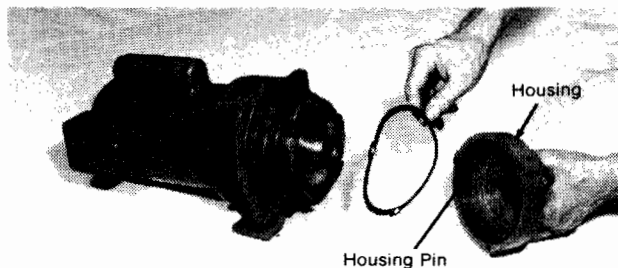

Figure 15



Figure 16

11. After pump is assembled and three holding screws are tightened, pump shaft must turn freely by hand before unit is placed in case.
12. If pump is not free, loosen three screws slightly and tap housing lightly until shaft turns freely, then re-tighten screws.
13. Rubber "O" ring must be in place in case before re-assembling pump unit into case. (See Fig. 16).
14. Replace case gasket if old one is torn or dried out.

Replacing Motor:

HCM - HC

1. If necessary to replace motor, pump must be completely dismantled and reassembled per instructions.
2. THIS IS IMPORTANT FOR PROPER IMPELLER AND MECHANICAL SEAL SPACING.
3. The practice of loosening set screws in shaft, removing motor and replacing with new motor without taking pump apart is not recommended.
4. Improper spacing of impeller or seal can cause early seal failure or possible motor failure.
5. Only complete motors are used with HCM and HC pumps. (See Fig. 14 for proper seal spacing.)

Tank Mounted Units:

HCM - HC

1. All general instructions for HCM and HC units apply to tank mounted pumps.
2. With tank mounted unit the air control must be connected at time of installation.
3. Always install air control in position shown and connect to pump in accordance with instructions given under installation instructions HCM-HC. (See Fig. 17).

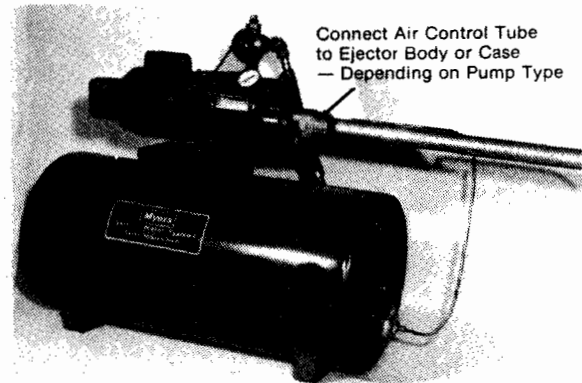

Figure 17

4. Follow color coding and catalog number for proper combination of basic tank mounted unit and ejector package. HCM is blue, HC is green.

Lubrication:

1. No lubrication is needed on pump.
2. Motor bearings are sufficiently lubricated for five years. Take to authorized motor repair station for repacking.

How To Dismantle HC:

1. All pump parts of unit can be removed from case without disturbing well piping or tank piping.
2. Be sure to drain pressure tank before dismantling pump.
3. Disconnect pressure switch tube and remove case bolts.
4. Use heavy screwdriver behind bolt ears and pry motor bracket from case.
5. Remove diffuser plate bolts and take off screen and diffuser plate.
6. Remove impeller with pliers. (See Fig. 18). RIGHT HAND THREAD CCW FACING THE IMPELLER TO REMOVE.

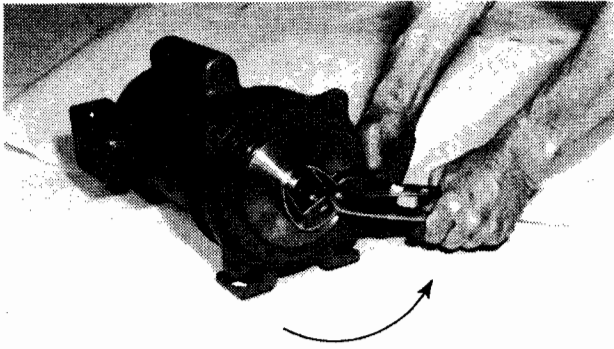

Figure 18

- 7. Seal is removed by holding shaft with pliers and turning bellows unit with a steady backward pull.
- 8. If necessary to remove pump shaft, use jack puller, Myers No. 10575B. (See Fig. 19).

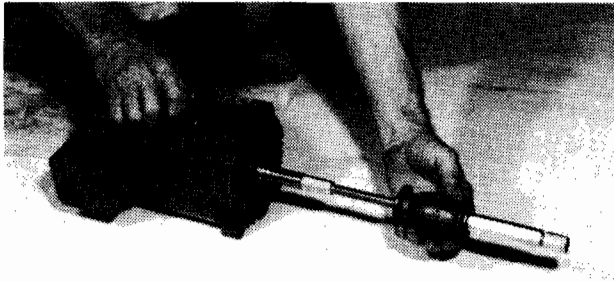

Figure 19

- 9. When shaft is replaced on motor it must be set in the correct position to give proper seal spacing for seal.
- 10. Mount stainless steel pump shaft on motor shaft and tighten set screw lightly.

- 11. Mount motor to bracket with shaft extending through ceramic seal ring.
- 12. Measure from ceramic seal face to shank on shaft. This length must be 23/32". (See Fig. 14).
- 13. If this dimension is not correct, adjust shaft to meet dimension, then tighten set screws.
- 14. The motors shipped with HC units have the shaft spotted to properly position pump shaft but, if necessary to replace a motor in the field, the new motor may not have the required spotting.
- 15. When pump is re-assembled the priming screen must be installed with the dimple "DOWN." THIS IS IMPORTANT FOR PUMP TO PRIME PROPERLY.
- 16. Pump shaft must turn freely with fingers after diffuser plate and screen are bolted in place.

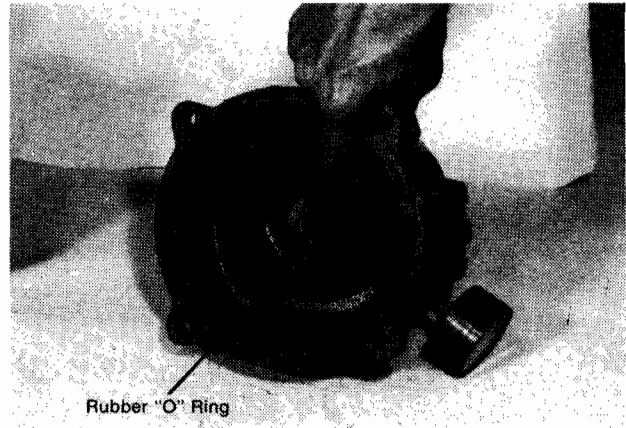
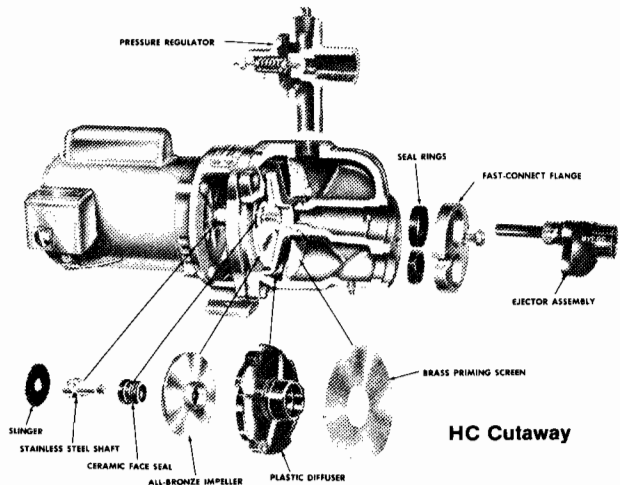
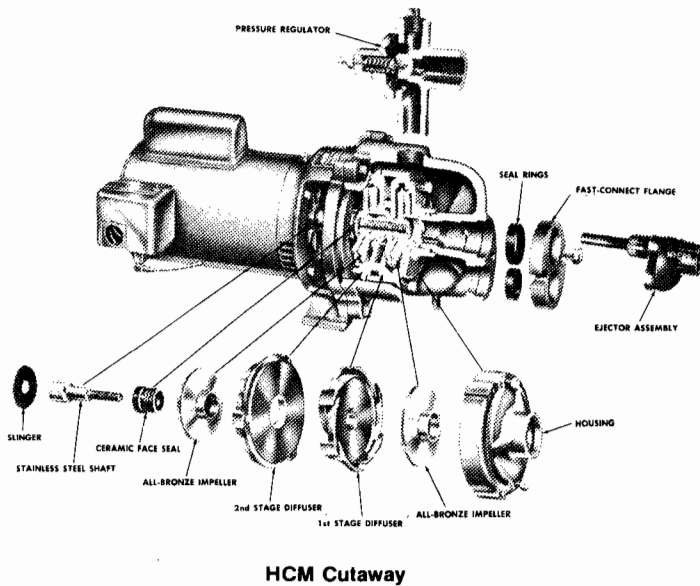

Figure 20

- 17. Rubber "O" ring must be in case before mounting bracket to case. (See Fig. 20).
- 18. Always replace case gasket if torn or dried out.
- 19. Pump shaft must turn clockwise when looking at end of motor opposite shaft extension.



If Pump Does Not Operate Properly Use Following Check List To Locate Trouble

SHALLOW WELL PUMPS

Pump Will Not Prime:

1. Stop motor, remove nylon plug and add water to case until full.
2. Check suction line for leaks and high spots or low spots.
3. Check air control tube and fittings for leaks. Best way to find leaks is to pump air into pump and piping and check all joints with soapsuds. This method will detect small leaks much better than a water pressure test.
4. Suction lines must slope from pump to well without dips or high spots.
5. Pump shaft must turn clockwise when viewed from motor end opposite shaft.
6. Check ejector for plugged nozzle or venturi tube.
7. Be sure rubber "O" ring is in place in diffuser vane plate. It is necessary to disassemble pump to check this.
8. Brass perforated screen must be in place, bolted to diffuser vane plate with the dimple down.
9. Be sure foot valve is not setting in sand or mud and that it is not stuck shut.

Pump Delivers Water For A Period, Then Stops:

1. Be sure water is not drawing below foot valve.
2. Check for plugged or worn nozzle or venturi tube.
3. Check for plugged impeller parts.
4. Air control diaphragm may be broken allowing air to enter pump suction.

Pump Does Not Deliver Rated Capacity:

1. Check nozzle and venturi for partial plugging or wear.

2. Check suction lift when pump is operating, using vacuum gauge in suction line at pump. The vacuum gauge reads total suction lift at this point. All capacity ratings are based on total suction lift, not elevation.
3. "O" ring seal for diffuser vane plate must be in place.
4. Check pressure gauge—it may be defective resulting in false readings.

Tank Becomes Water-Logged:

1. Drain tank and restart pump.
2. Check all connections in tank, above water level, for air leaks. Use soapsuds.
3. Check air control and fittings for proper operation.
4. Be sure air control tube is installed in proper place. See installation instructions.
5. If water enters pump suction under some pressure a valve must be installed in suction line so that it can be throttled enough to create vacuum at air control tube connection.
6. Air control must be installed low on tank. If installed more than half way up on tank, it will not provide sufficient air and water-logging will result. If an existing tank is used that has no air control tapping below center of tank, air control must be installed in a tee in the discharge pipe from pump. THIS IS IMPORTANT.

Motor Does Not Operate Properly:

1. Remove motor and take to authorized motor service station.

DEEP WELL PUMPS

Pump Will Not Prime:

1. Stop motor, remove nylon plug and regulator poppet and add water to case.
2. If pump is offset, check horizontal piping for dips or high spots. Pipe must have gradual slope from pump downward to well.
3. Check well water level to be sure ejector is in water.
4. Check piping and pump for air leaks.
5. Take pump apart to check if diffuser vane plate "O" ring is properly positioned.
6. Be sure motor is running in correct rotation. Rotation is clockwise when viewed from motor end opposite shaft.
7. Pull well piping to check ejector for plugged nozzle or venturi.
8. Be sure foot valve is not setting in sand or mud.

Pump Delivers Water For A Period, Then Stops Pumping:

1. Check well to see if water is drawing below foot valve. Make this test with water level tester when pump is operating.
2. Be sure regulator is set properly especially if well draws down. Regulator must be set to provide minimum operating pressure at the maximum draw down.
3. Pull well pipes and check ejector for plugged nozzle or venturi.

Pump Delivers Water But Will Not Kick Off Pressure Switch:

1. Well may be drawing down below limit of ejector. Check well water level when pump is operating.
2. Be sure tube from pressure switch to pump is not plugged.
3. Check pressure switch for defects.
4. Check for wear at impeller neck.
5. Be sure diffuser vane plate "O" ring is in proper place.

Pump Does Not Deliver Rated Capacity:

1. Check well lift. Use water level tester when pump is operating.
2. Check submergence of ejector. If ejector is installed more than 10 feet below pumping level, capacity will be reduced due to increased friction in piping.
3. Operating pressure may be too high. Set regulator to minimum operating pressure listed for pump size being checked.
4. Check air control tube and connecting fittings for leaks.
5. Pull well pipe and check ejector for proper size and setting depth.

Tank Becomes Water-Logged:

1. Drain tank and re-start pump.
2. Check all connections in tank above water line for air leaks. Use soapsuds.
3. Check air control and fittings for proper operation.
4. Be sure air control tube is installed in proper place. See installation instructions.
5. Be sure pressure regulator is properly set. If set higher than the minimum operating pressure listed in catalog, air control will not operate properly. This minimum pressure must show on pump gauge at the instant pump starts. If pressure is above minimum at time pump starts, unscrew nylon regulating stem until pressure is right at instant pump starts.
6. If an existing tank is used that has no air control connection at center of tank or lower, air control must be installed in tee in discharge line from pump to tank.

Motor Fails Or Does Not Operate Properly:

1. Remove from pump and take to authorized motor service station for repair.

Myers®

F.E. Myers, 1101 Myers Parkway, Ashland, Ohio 44805-1969 • 419/289-1144