

500 G.P.M. 912 SERIES

50 HERTZ ELECTRIC MOTOR DRIVE

SIZE : 4-481-11D/ 4-483-11D MODEL: 480 IMPELLER : Enclosed R. P. M. : 2950

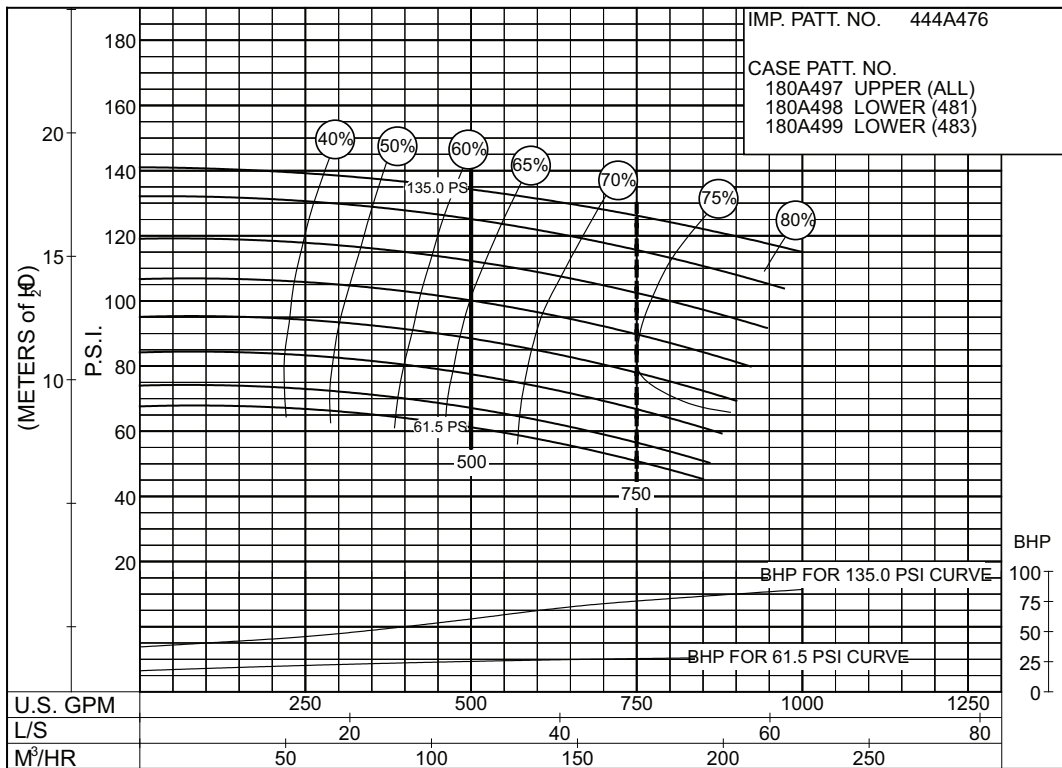

PC-193678

61 to 134 P.S.I.

SIZE : 5-485-12 MODEL: 480 IMPELLER : Enclosed R. P. M. : 2950

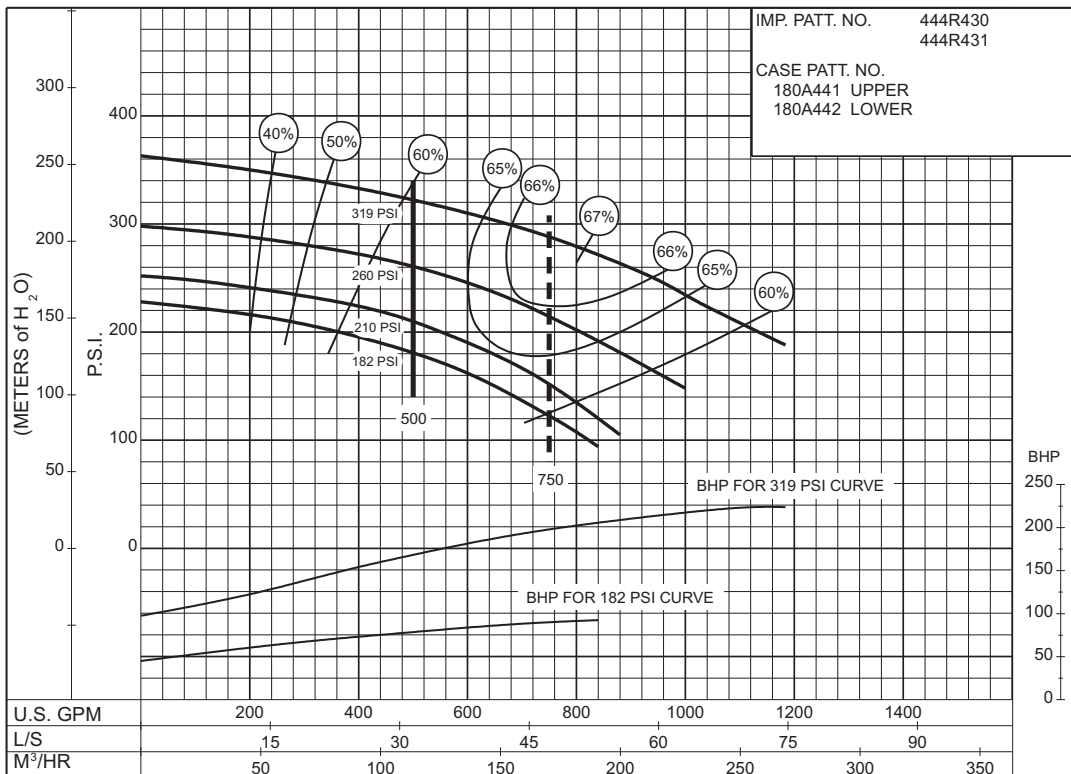

PC-174443

180 to 320 P.S.I.



AURORA®

500 G.P.M. 912 SERIES

50 HERTZ ELECTRIC MOTOR DRIVE

SIZE: 6"-1923F

MODEL: 1900

IMPELLER : Enclosed

R. P. M. : 2950

IMP. PATT. NO. 444S490 & 444S491
 CASE PATT. NO. Upper Patt. No : 180A511
 Lower Patt. No : 180A512

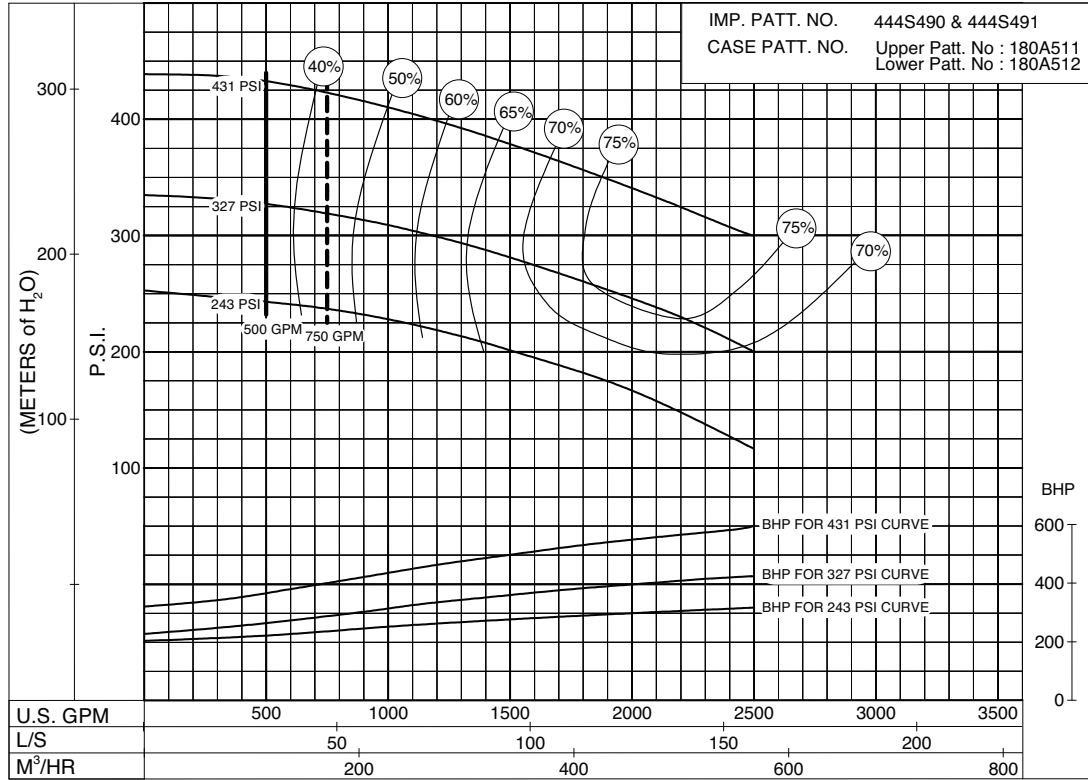

**243
to
431
P.S.I.**

PC-201248

THIS PAGE LEFT INTENTIONALLY BLANK

500 G.P.M. 912 SERIES

50 HERTZ ELECTRIC MOTOR DRIVE

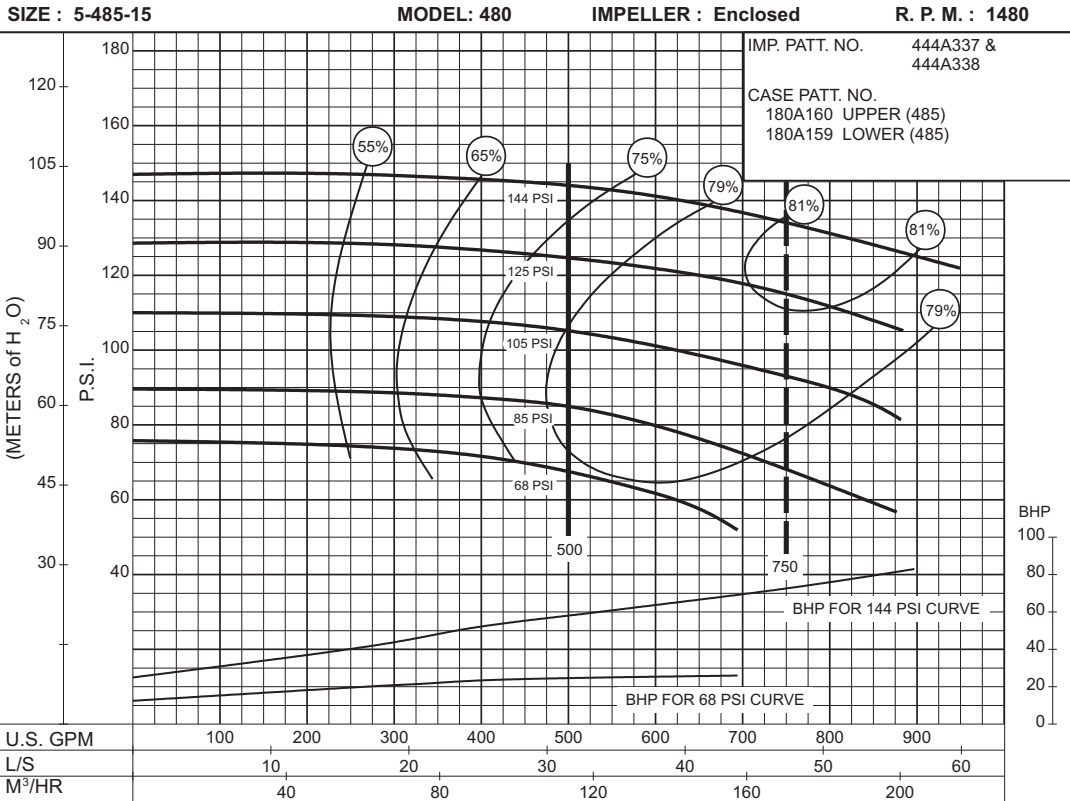

68 to 144 P.S.I.

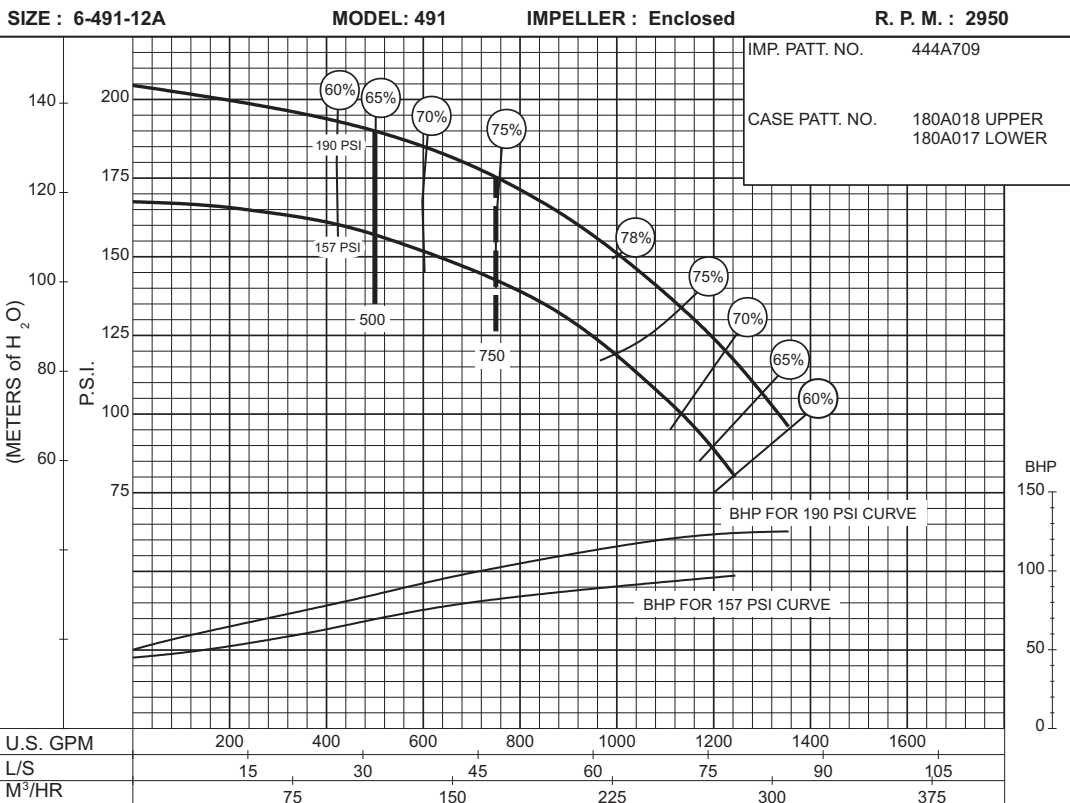

157 to 190 P.S.I.

750 G.P.M. 912 SERIES

50 HERTZ ELECTRIC MOTOR DRIVE

SIZE : 4-491-8A

MODEL: 491

IMPELLER : Enclosed

R. P. M. : 3000

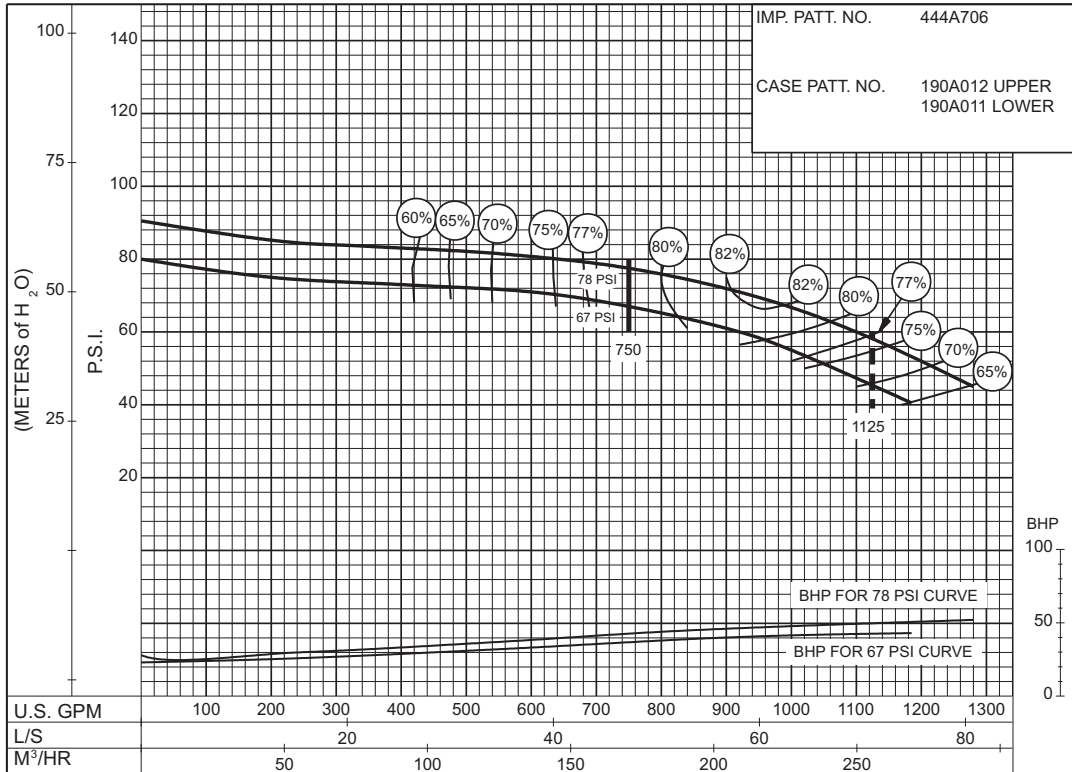

PC-171333

67 to 78 P.S.I.

SIZE : 6-485-17A

MODEL: 480

IMPELLER : Enclosed

R. P. M. : 1480

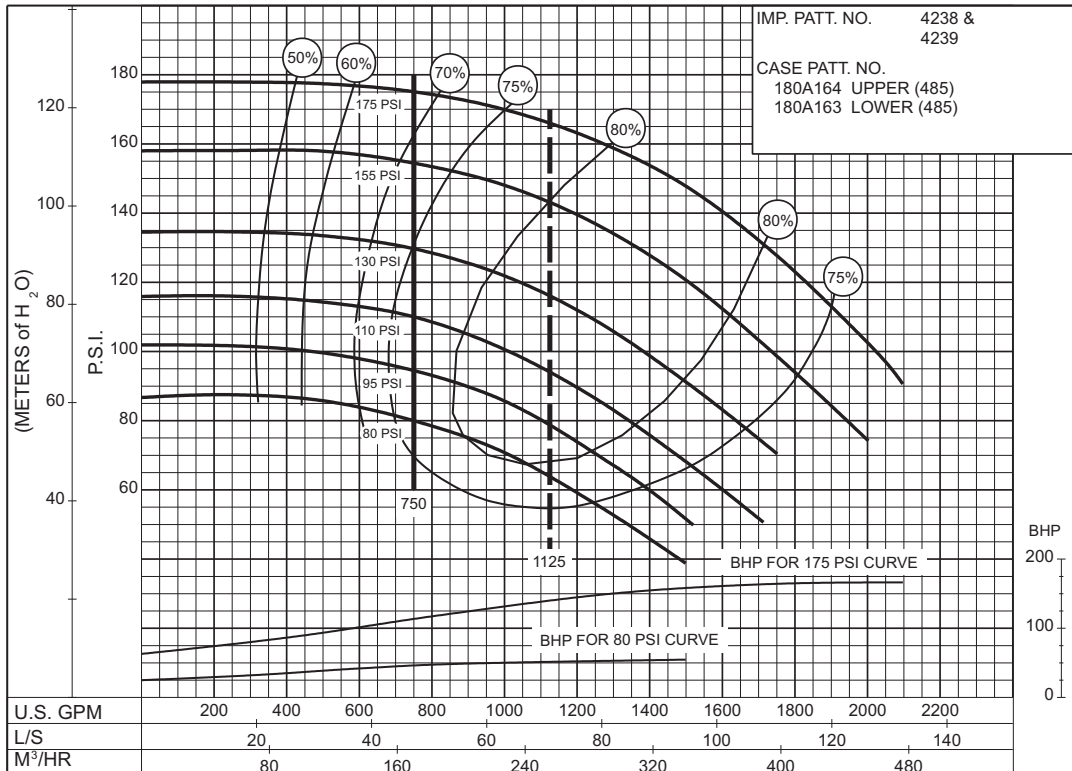

PC-147570A

80 to 175 P.S.I.



AURORA®

750 G.P.M. 912 SERIES

50 HERTZ ELECTRIC MOTOR DRIVE

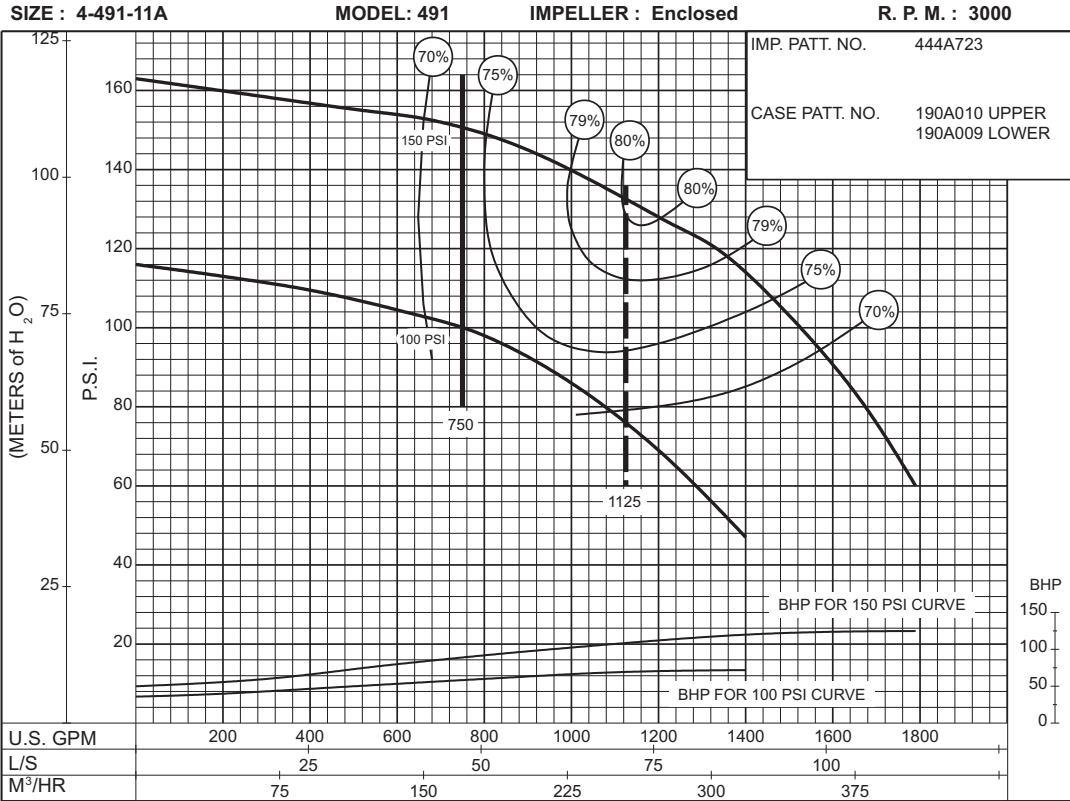

**100
to
150
P.S.I.**

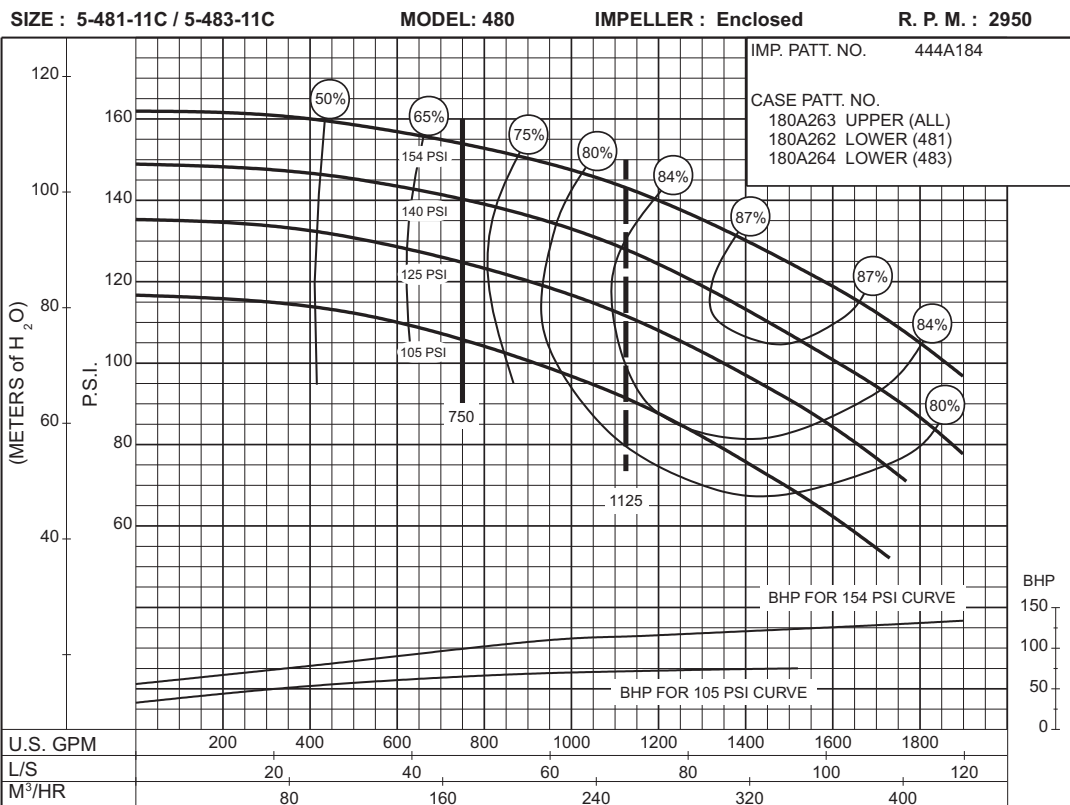

**105
to
154
P.S.I.**

750 G.P.M. 912 SERIES

50 HERTZ ELECTRIC MOTOR DRIVE

SIZE : 6-491-12A

MODEL: 491

IMPELLER : Enclosed

R. P. M. : 2950

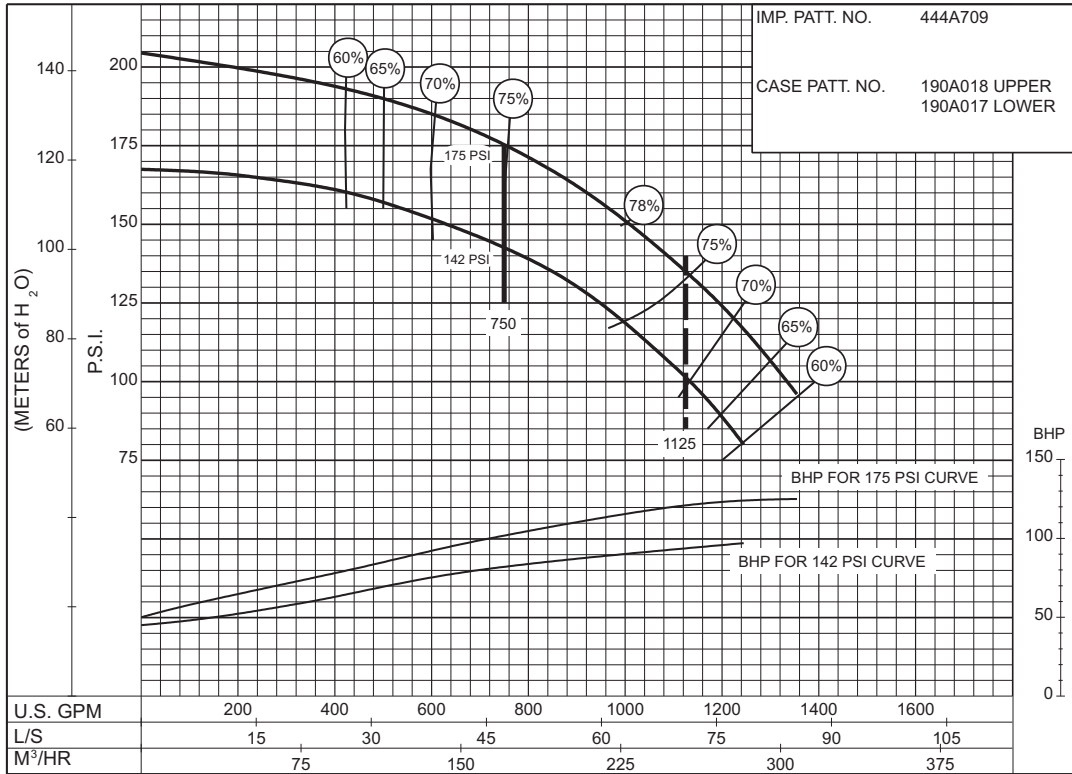

PC-171335

142 to 175 P.S.I.

SIZE : 6-485-12

MODEL: 480

IMPELLER : Enclosed

R. P. M. : 2950

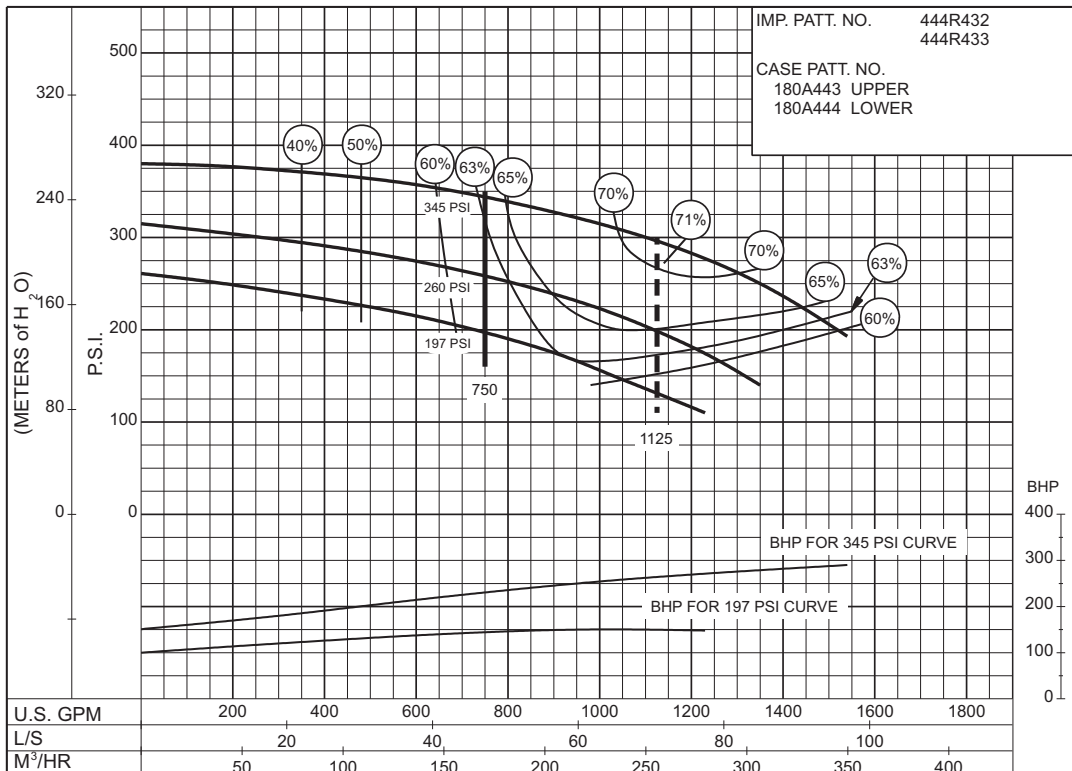

PC-174446

197 to 345 P.S.I.

750 G.P.M. 912 SERIES
50 HERTZ ELECTRIC MOTOR DRIVE

SIZE: 6-485-16

MODEL: 485

IMPELLER : Enclosed

R. P. M. : 2950

IMP. PATT. NO. 444S490 & 444S491
CASE PATT. NO. Upper Patt. No : 180A511
Lower Patt. No : 180A512

**237
to
421
P.S.I.**

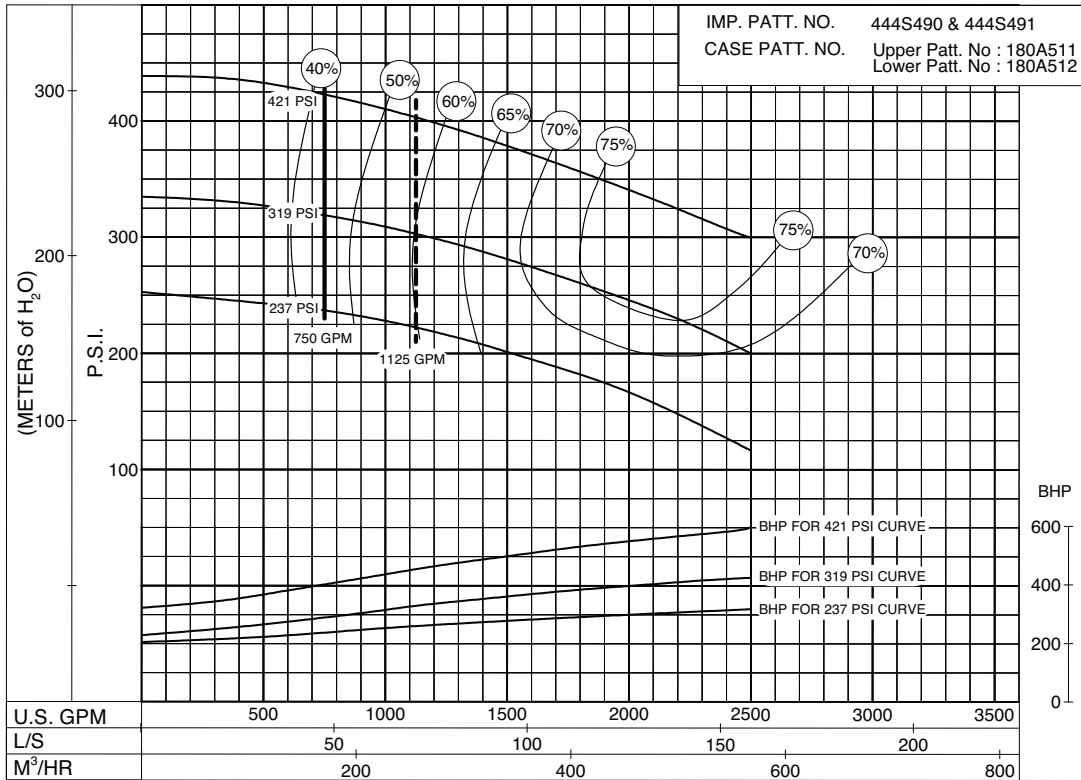

PC-200268A

**247
to
435
P.S.I.**

MODEL: 6-485-16B

RPM: 2950

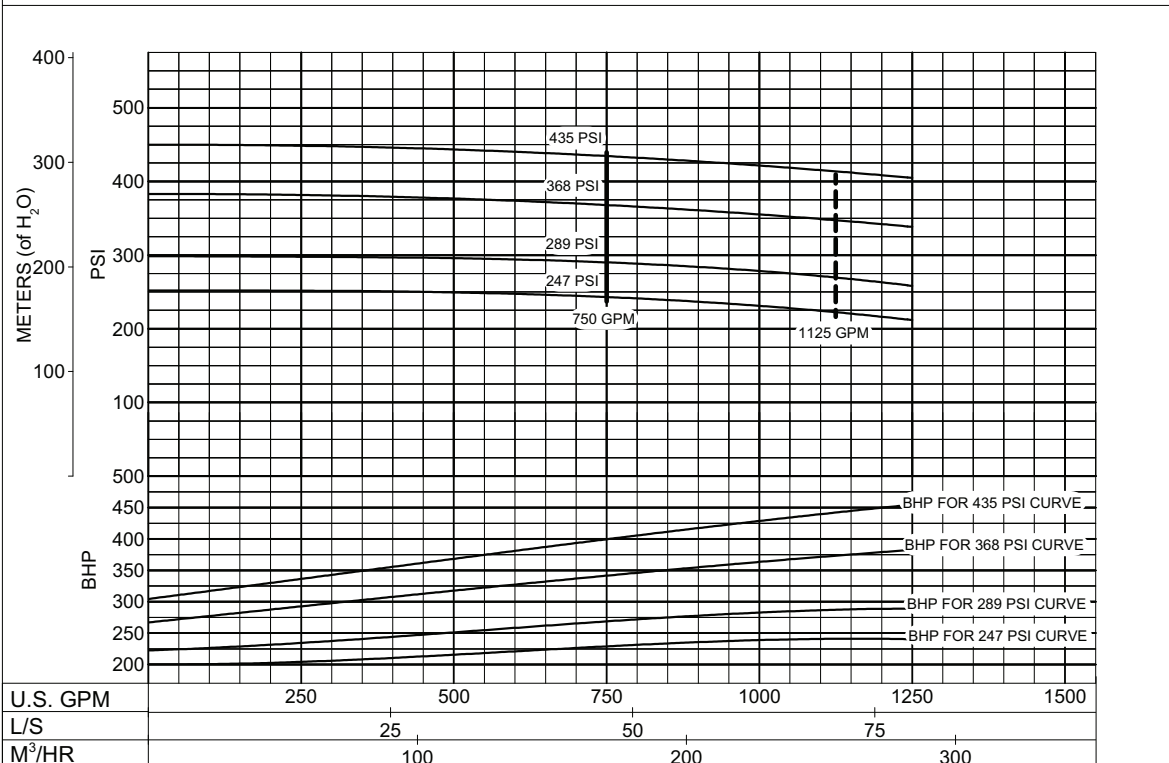

PC-204637A

THIS PAGE LEFT INTENTIONALLY BLANK

1000 G.P.M. 912 SERIES
50 HERTZ ELECTRIC MOTOR DRIVE

Supersedes Section 912 Page 608
 Dated March 2001

SIZE : 6-481-18C / 6-483-18C MODEL: 480 IMPELLER : Enclosed R. P. M. : 1480

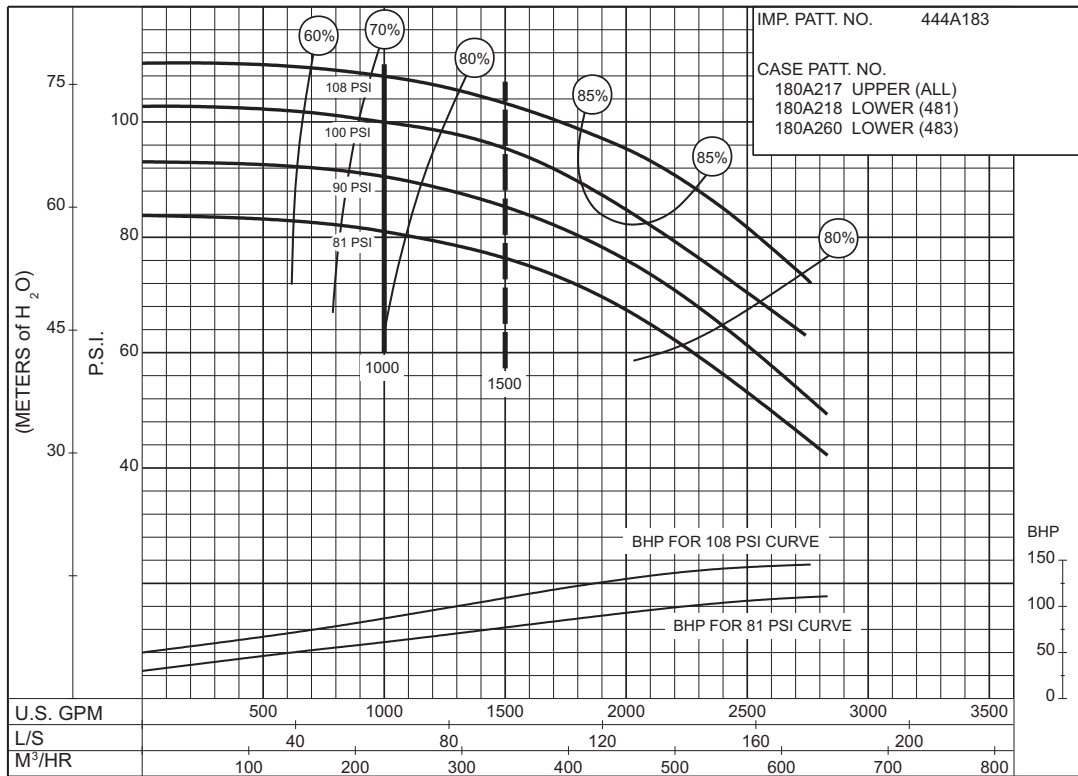

**81
 to
 108
 P.S.I.**

PC-147574A

1000 G.P.M. 912 SERIES

50 HERTZ ELECTRIC MOTOR DRIVE

SIZE : 5-492-10

MODEL: 491

IMPELLER : Enclosed

R. P. M. : 3000

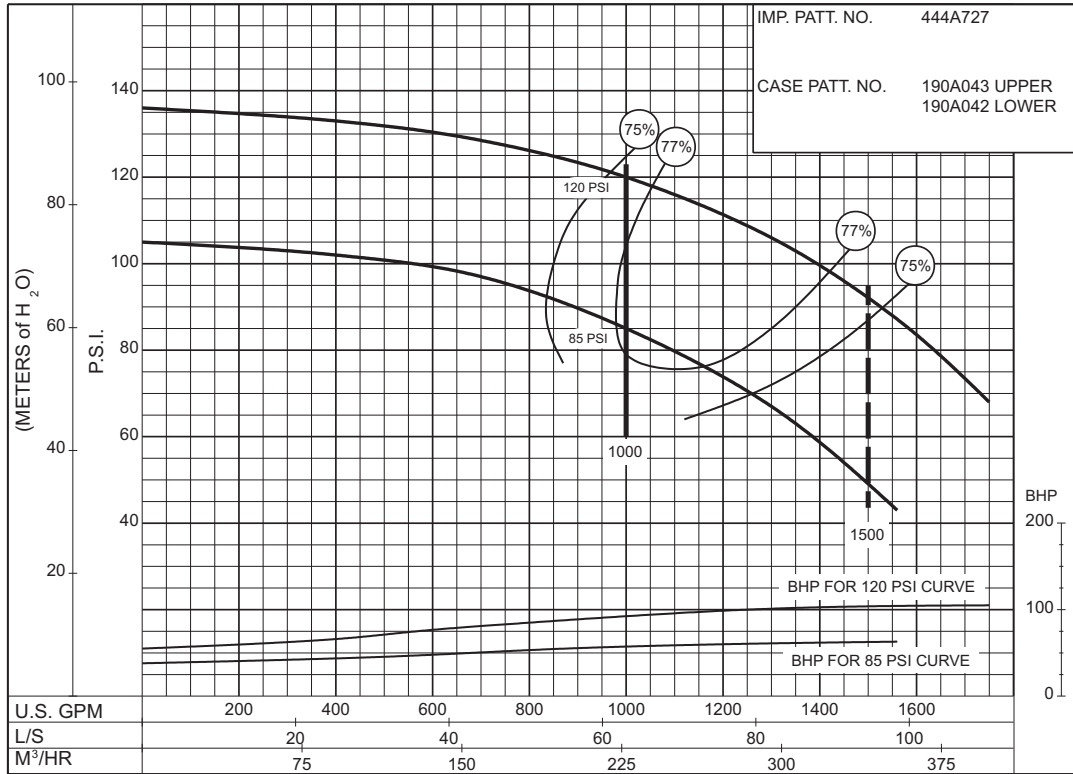

PC-171336

85 to 120 P.S.I.

SIZE : 5-481-11C / 5-483-11C

MODEL: 480

IMPELLER : Enclosed

R. P. M. : 2950

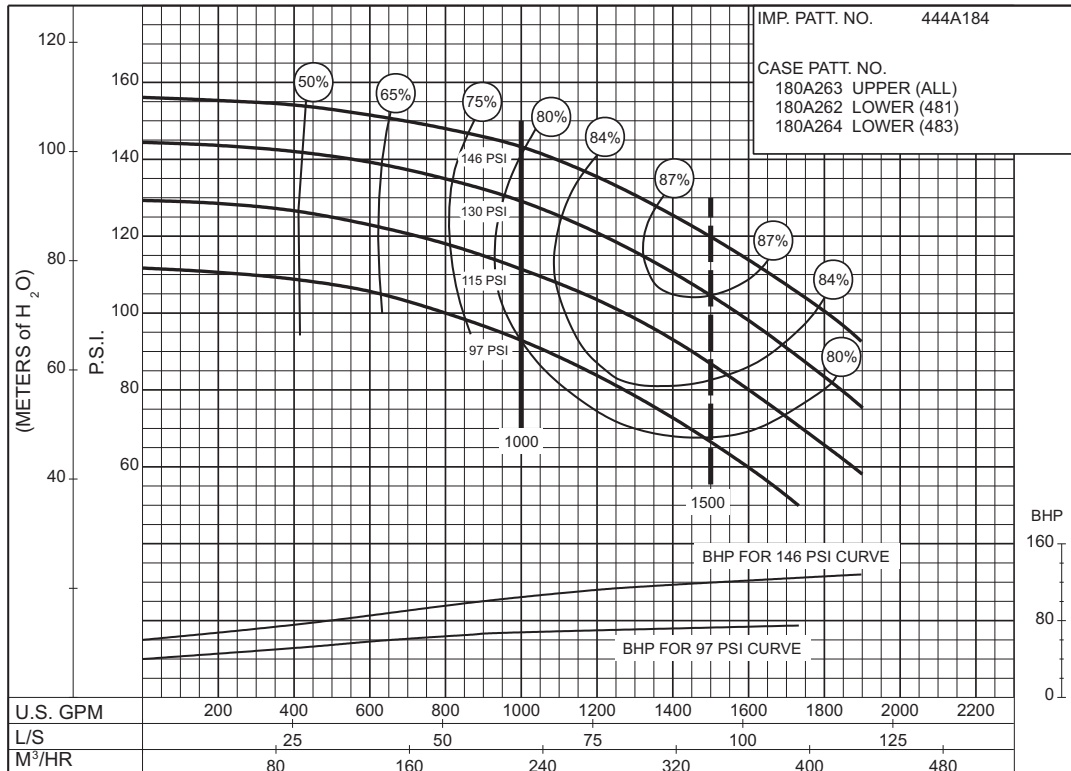

PC-147572A

97 to 146 P.S.I.

Section **912** Page **609.10**

Date **April 2000**

Supersedes Section 912 Page 609.1

THIS PAGE LEFT INTENTIONALLY BLANK

1000 G.P.M. 912 SERIES

50 HERTZ ELECTRIC MOTOR DRIVE

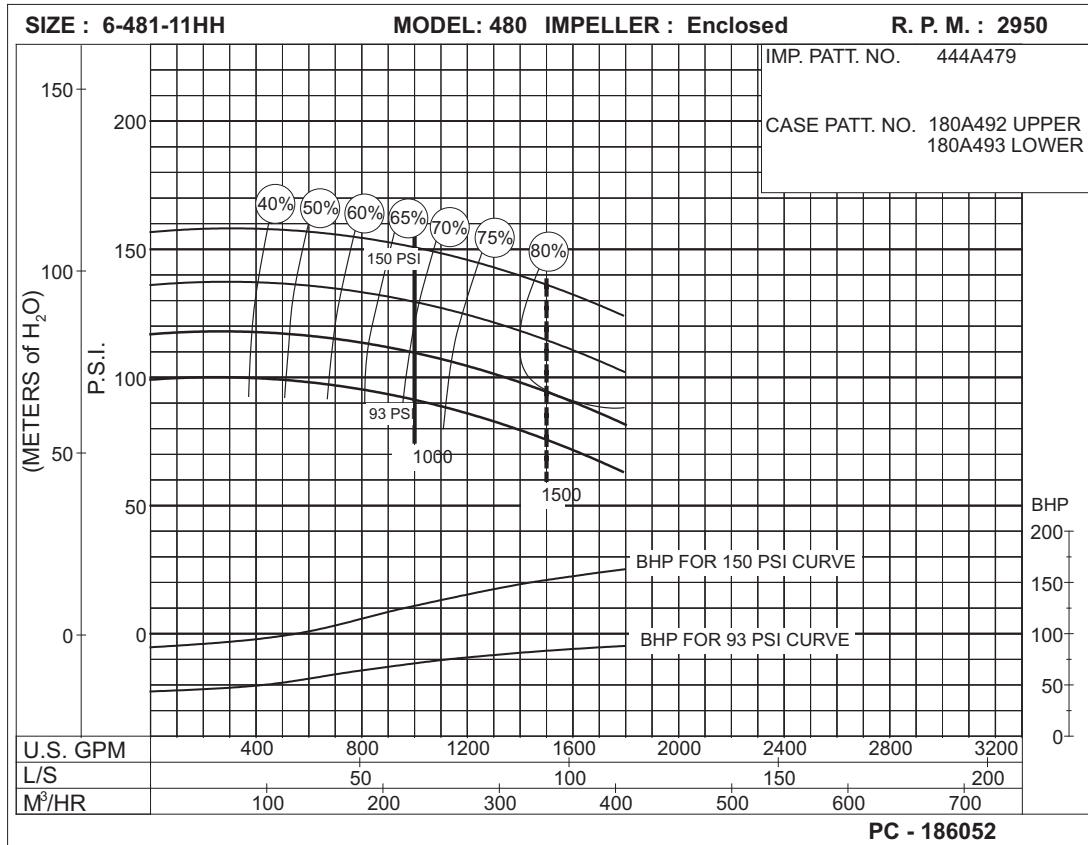

**93
to
150
P.S.I.**

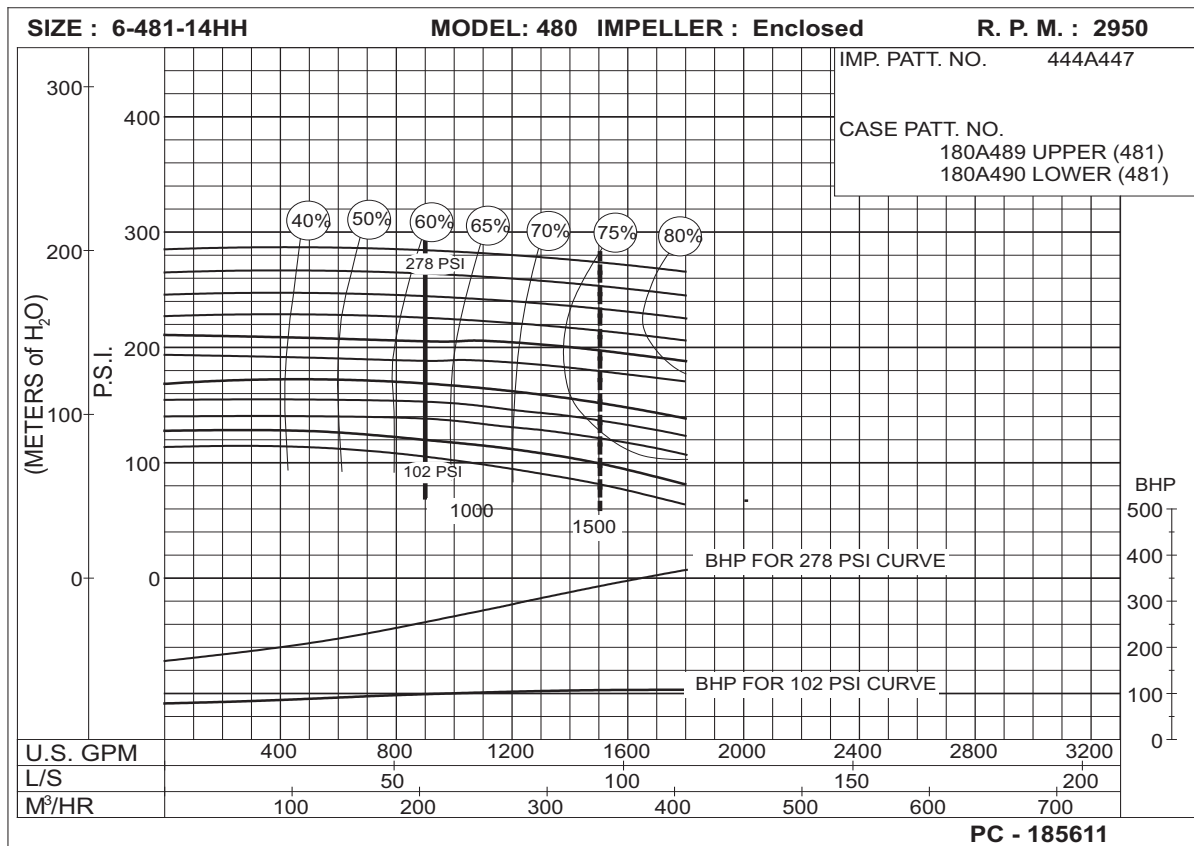

**102
to
278
P.S.I.**

1000 G.P.M. 912 SERIES
50 HERTZ ELECTRIC MOTOR DRIVE

SIZE: 6-485-16

MODEL: 485

IMPELLER : Enclosed

R. P. M. : 2950

IMP. PATT. NO. 444S490 & 444S491
 CASE PATT. NO. Upper Patt. No : 180A511
 Lower Patt. No : 180A512

**228
to
405
P.S.I.**

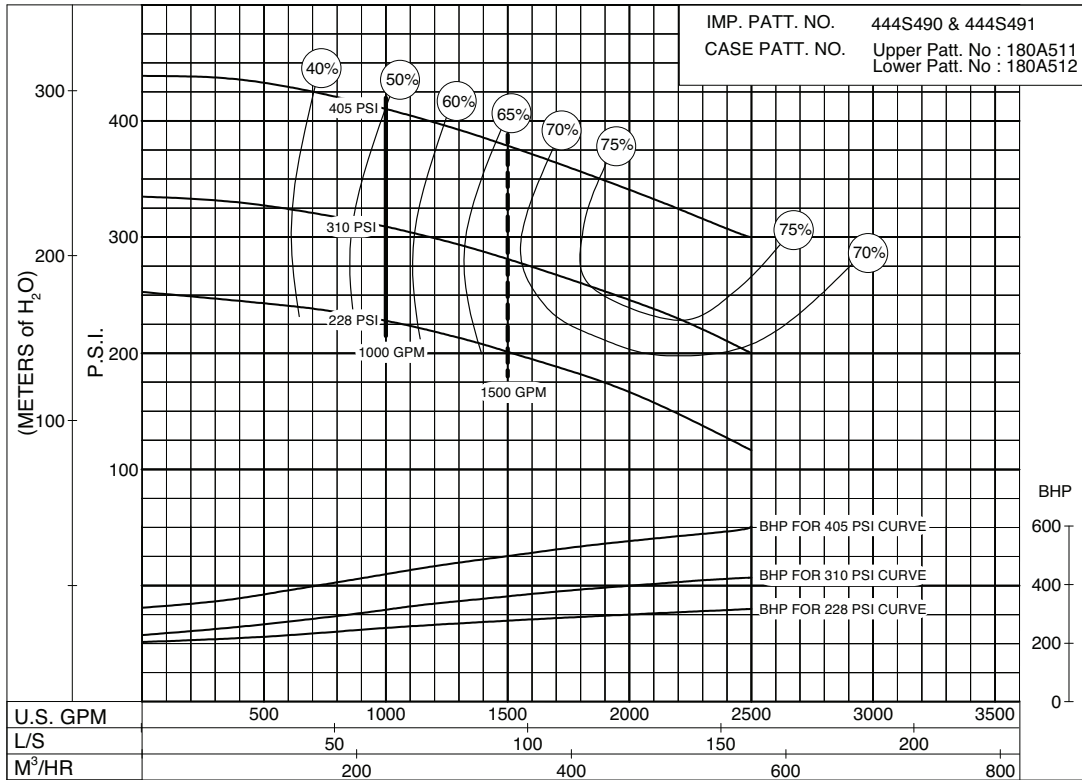

PC-200269A

**234
to
425
P.S.I.**

MODEL: 6-485-16B

RPM: 2950

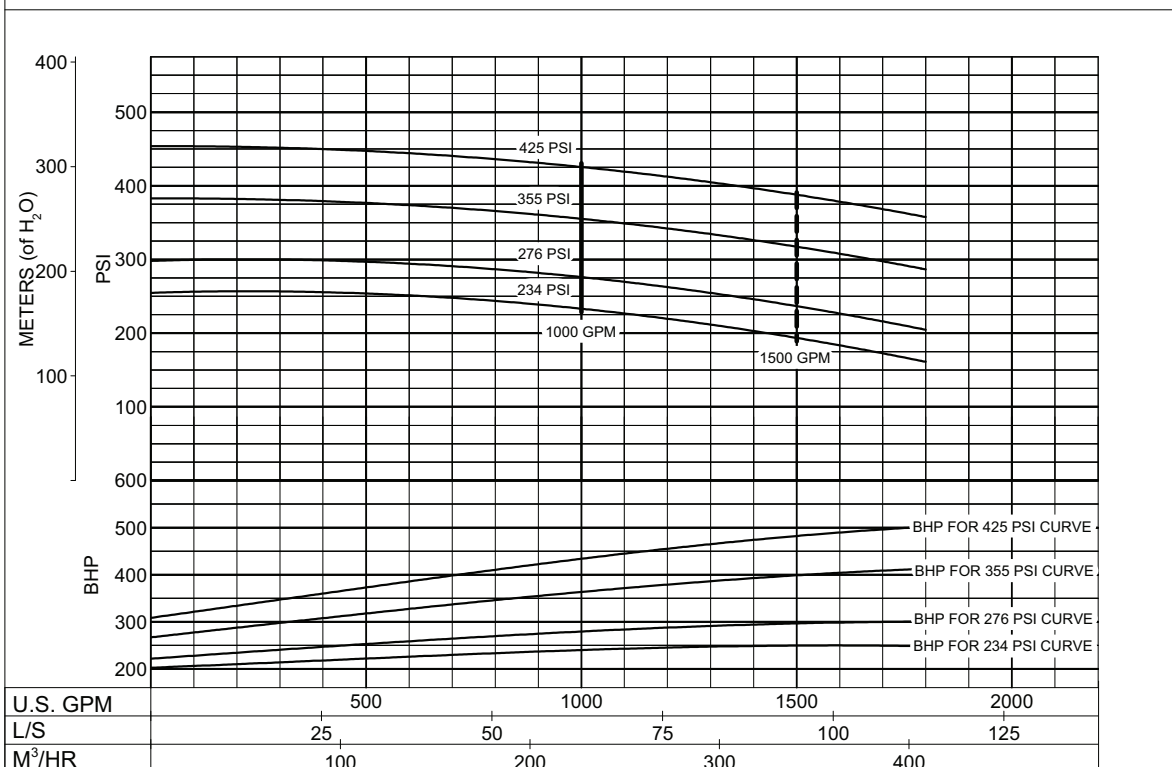

PC-204638A

1250 G.P.M. 912 SERIES

50 HERTZ ELECTRIC MOTOR DRIVE

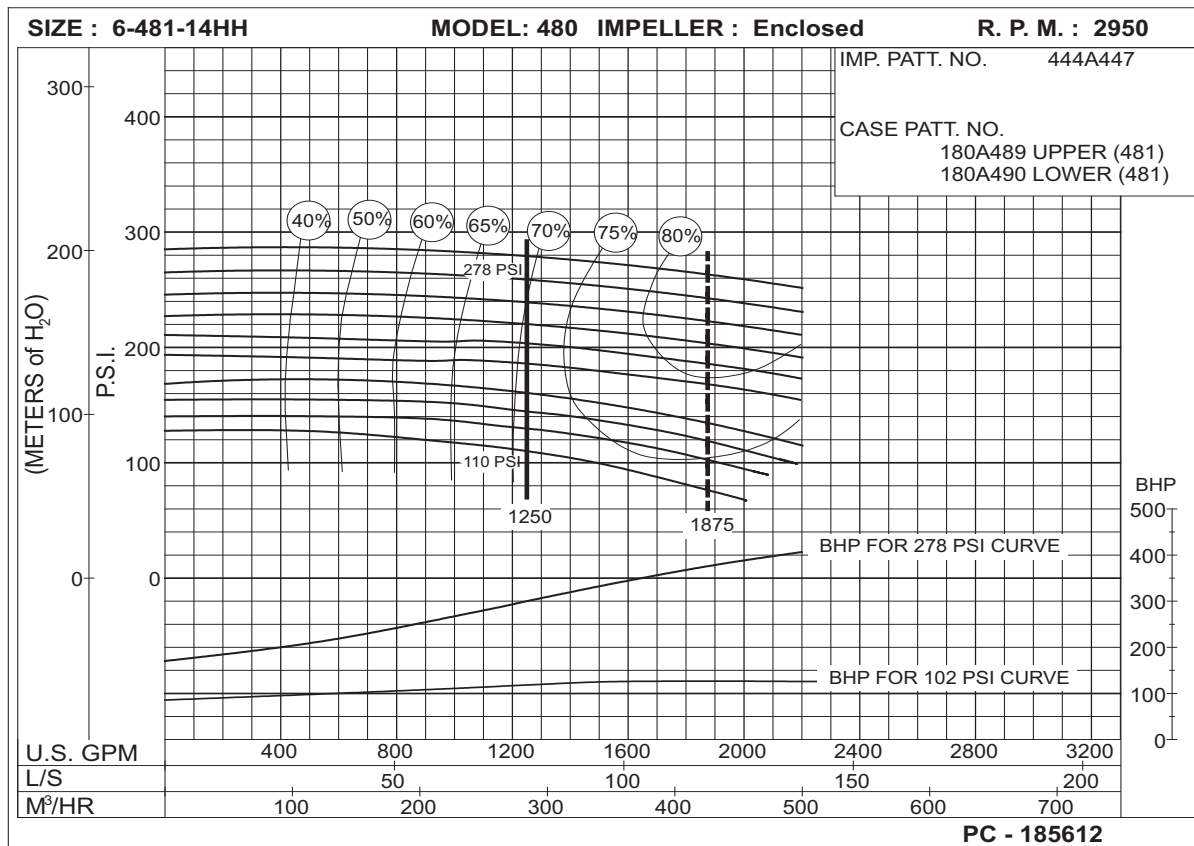
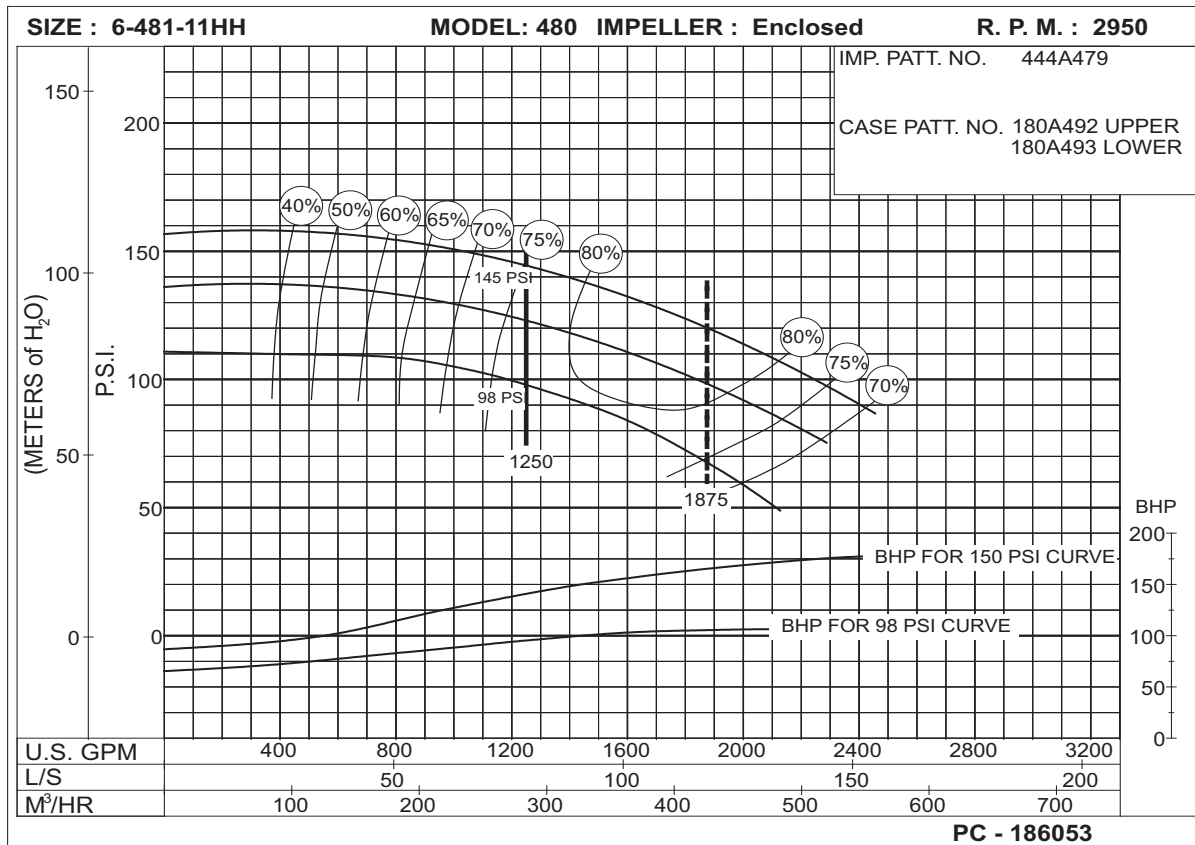

1250 G.P.M. 912 SERIES
50 HERTZ ELECTRIC MOTOR DRIVE

SIZE: 6-485-16

MODEL: 485

IMPELLER : Enclosed

R. P. M. : 2950

IMP. PATT. NO. 444S490 & 444S491
 CASE PATT. NO. Upper Patt. No : 180A511
 Lower Patt. No : 180A512

**216
to
390
P.S.I.**

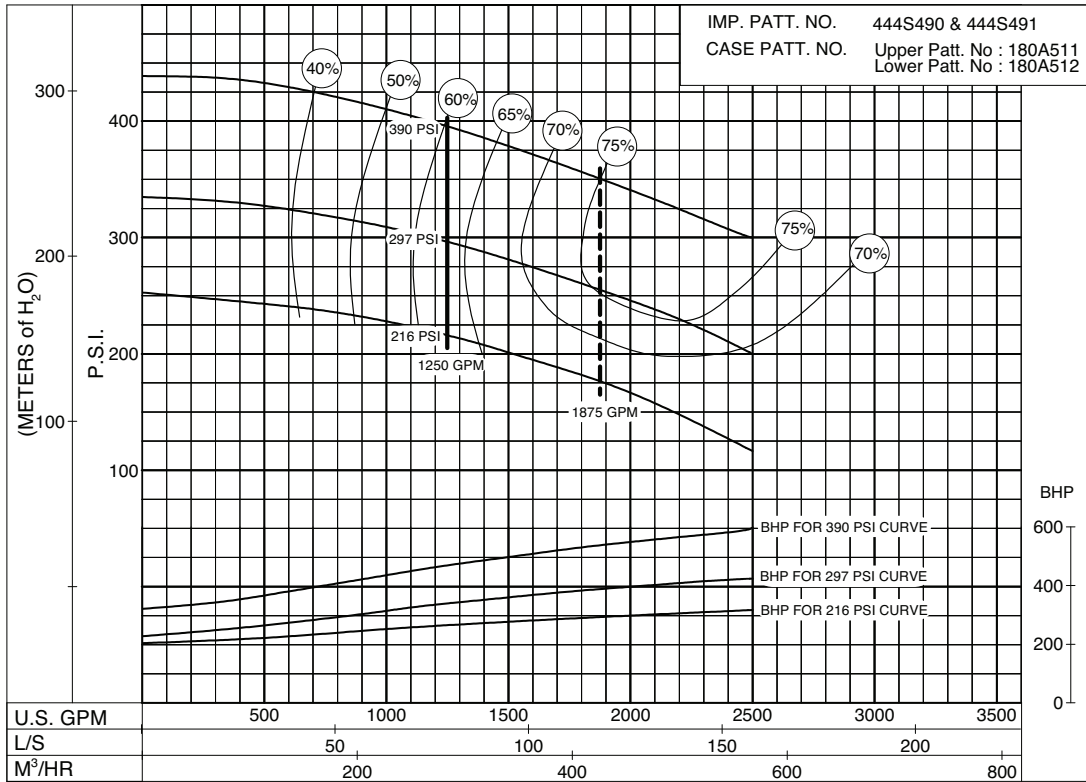

PC-200270A

**259
to
410
P.S.I.**

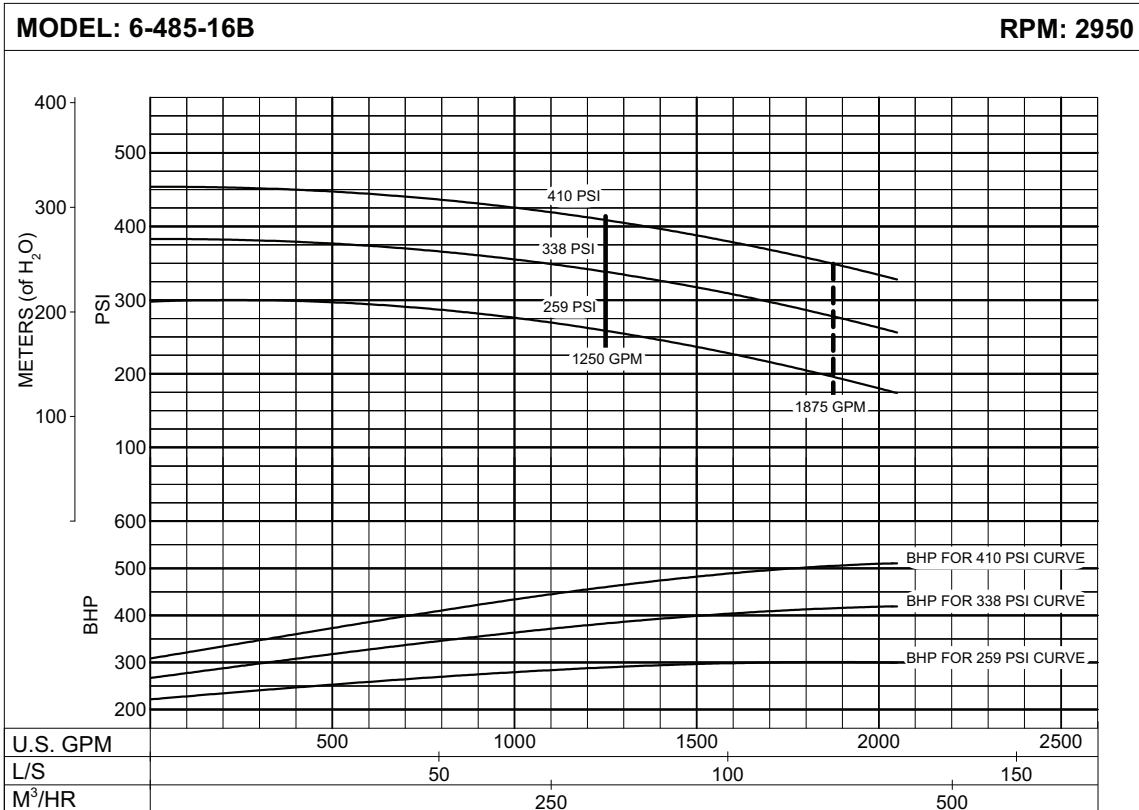

PC-204639A

1250 G.P.M. 912 SERIES

50 HERTZ ELECTRIC MOTOR DRIVE

SIZE : 6-481-18C / 6-483-18C

MODEL: 480

IMPELLER : Enclosed

R. P. M. : 1480

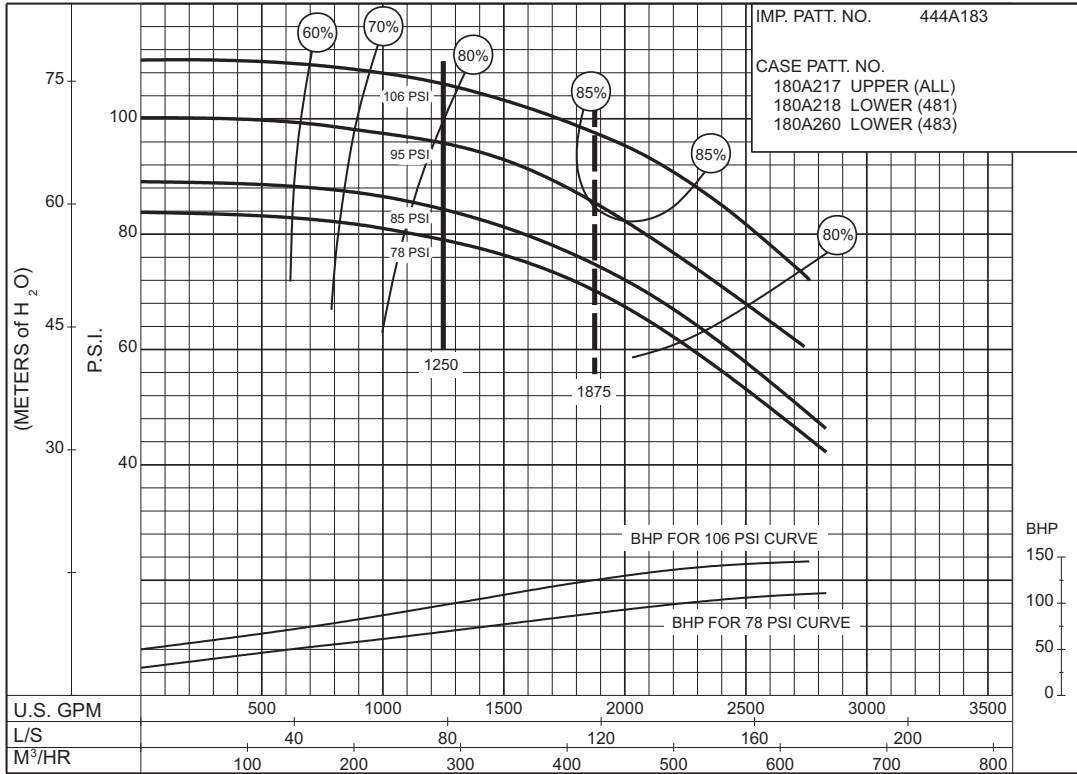

PC-147578A

78 to 106 P.S.I.

SIZE : 8-481-21

MODEL: 480

IMPELLER : Enclosed

R. P. M. : 1480

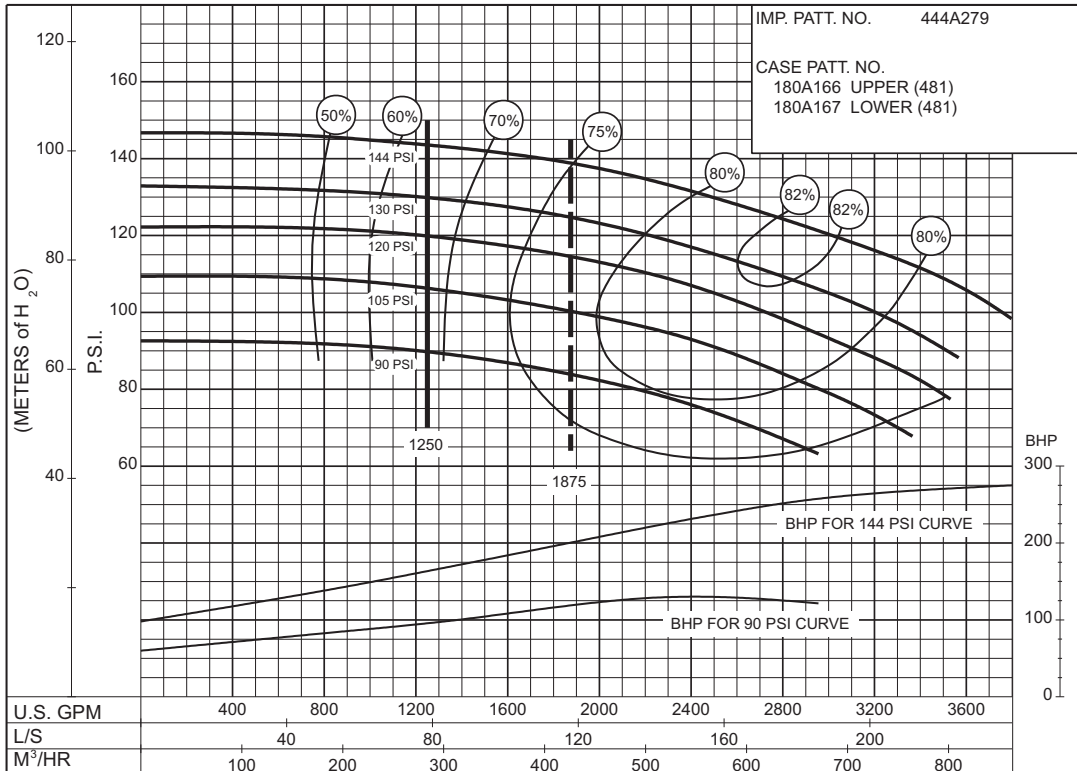

PC-147576A

90 to 144 P.S.I.

1500 G.P.M. 912 SERIES
50 HERTZ ELECTRIC MOTOR DRIVE

**121
to
137
P.S.I.**

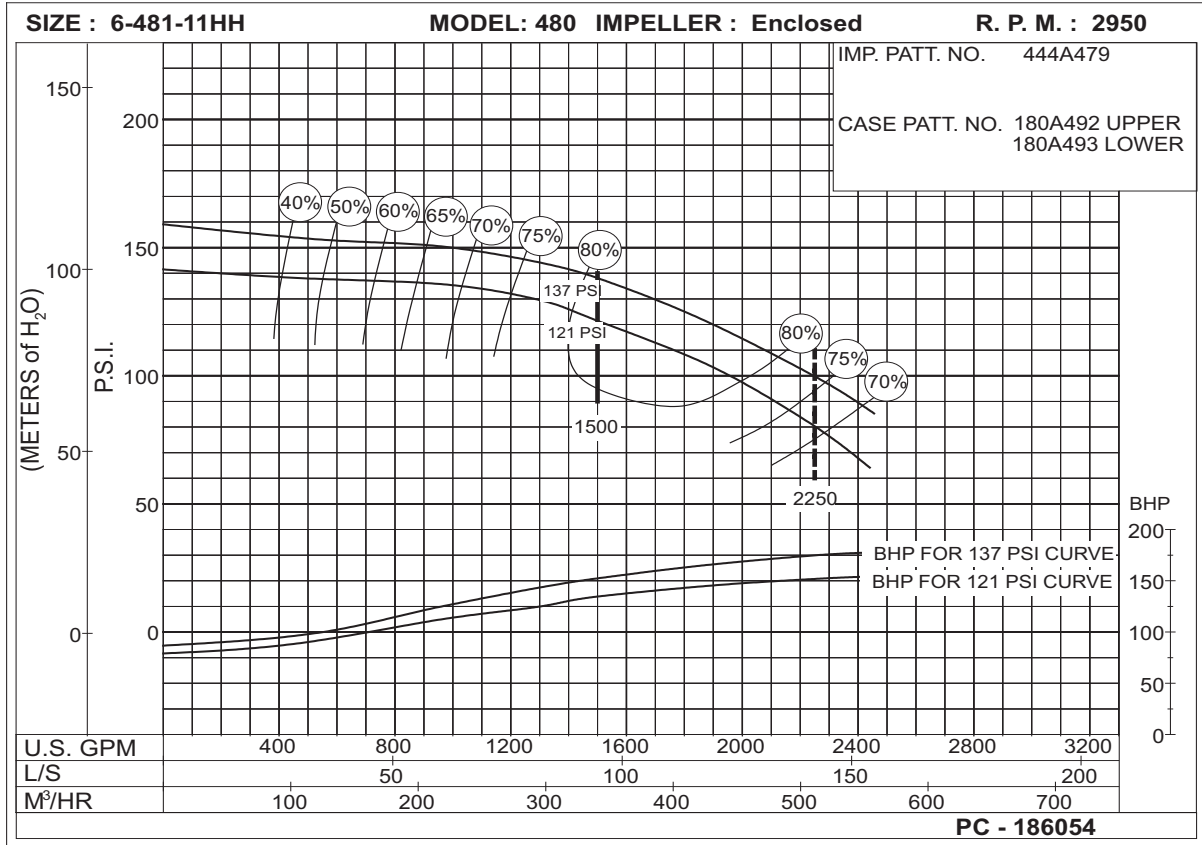

**110
to
275
P.S.I.**

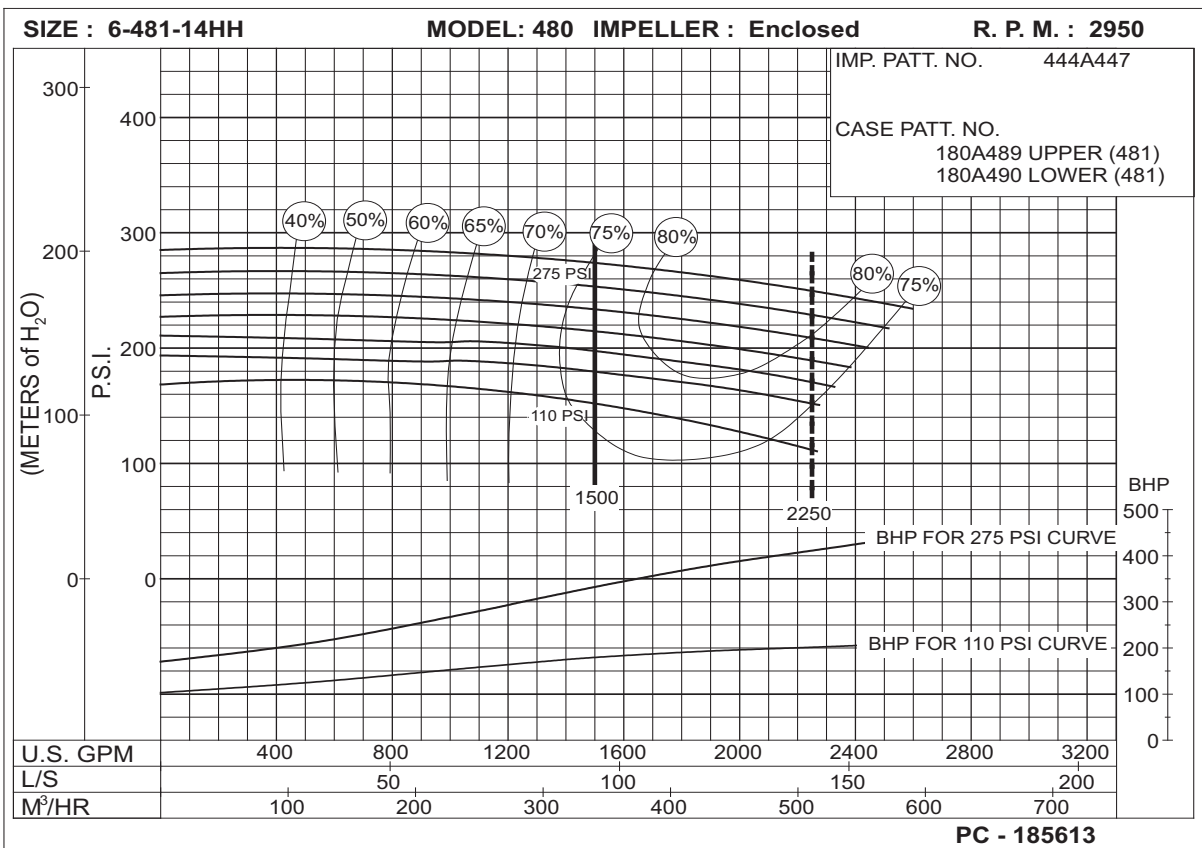

1500 G.P.M. 912 SERIES

50 HERTZ ELECTRIC MOTOR DRIVE

SIZE: 6-485-16

MODEL: 485

IMPELLER : Enclosed

R. P. M. : 2950

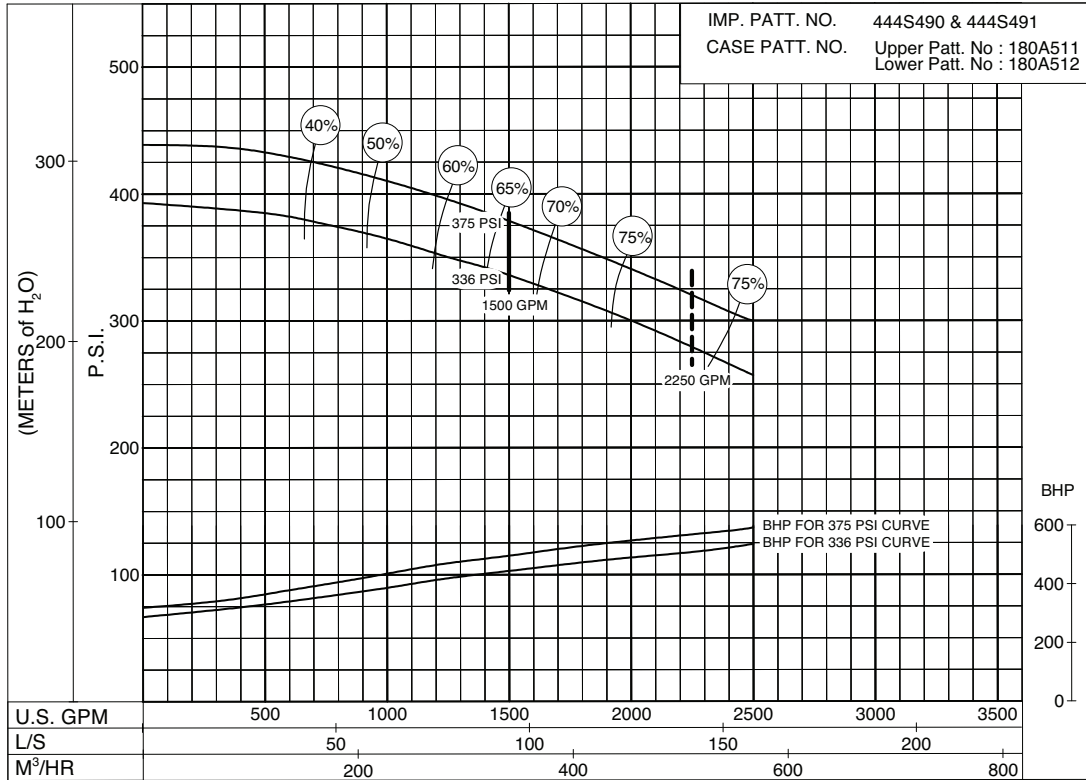

336
to
375
P.S.I.

PC-200271A

Section **912** Page **612.3**

Date **October 1, 2008**

Supersedes Section 912 Page 612.3

THIS PAGE LEFT INTENTIONALLY BLANK

1500 G.P.M. 912 SERIES

50 HERTZ ELECTRIC MOTOR DRIVE

SIZE : 6-481-18C / 6-483-18C

MODEL: 480

IMPELLER : Enclosed

R. P. M. : 1480

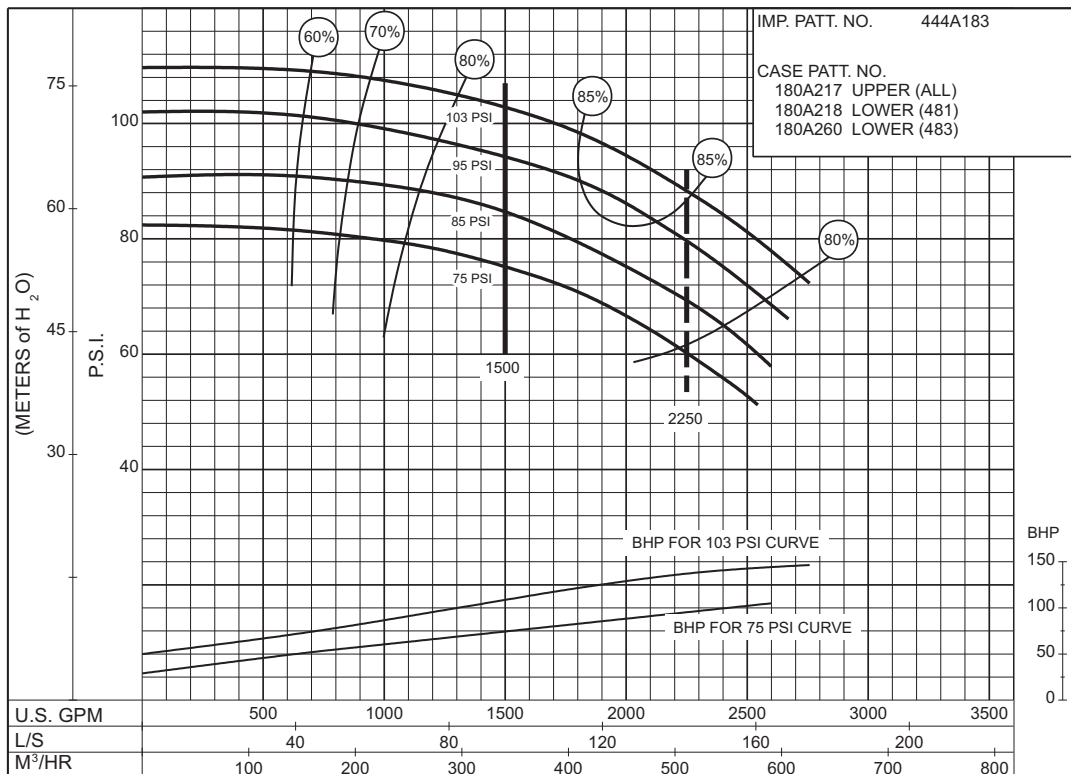

75 to 103 P.S.I.

PC-147582A

SIZE : 6-492-10

MODEL: 492

IMPELLER : Enclosed

R. P. M. : 3000

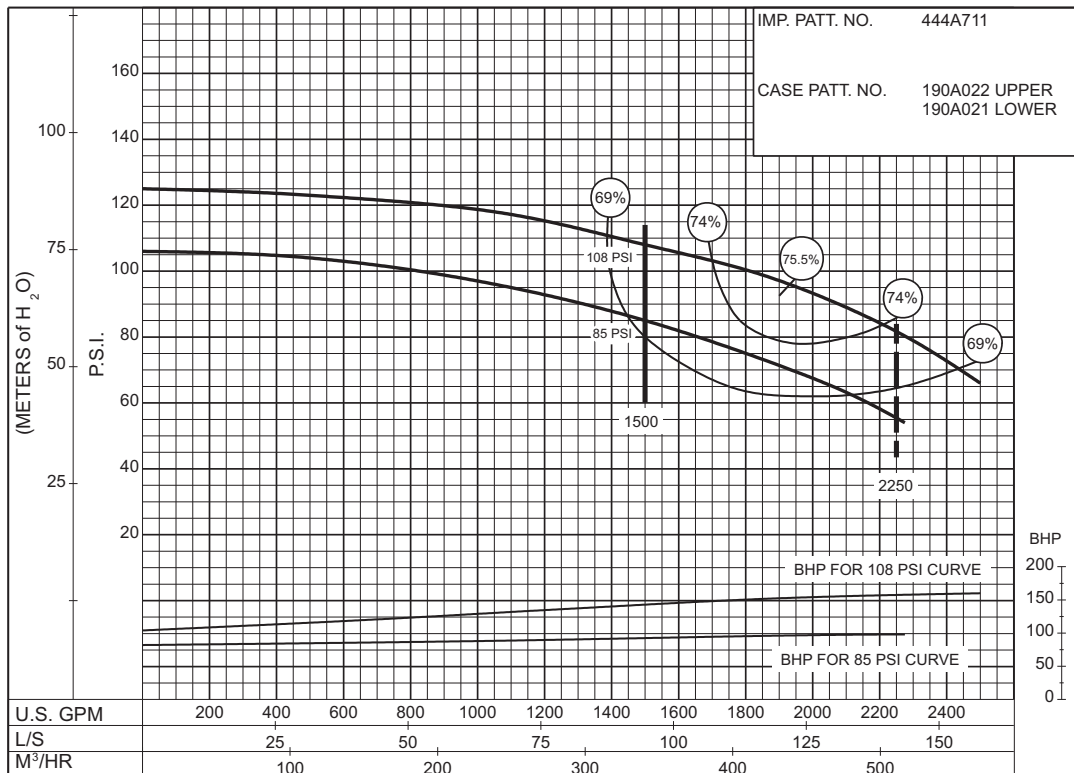

85 to 108 P.S.I.

PC-171337



AURORA®

1500 G.P.M. 912 SERIES 50 HERTZ ELECTRIC MOTOR DRIVE

SIZE : 8-481-21

MODEL: 480

IMPELLER : Enclosed

R. P. M. : 1480

IMP. PATT. NO. 444A279

CASE PATT. NO.
180A166 UPPER (ALL)
180A167 LOWER (481)

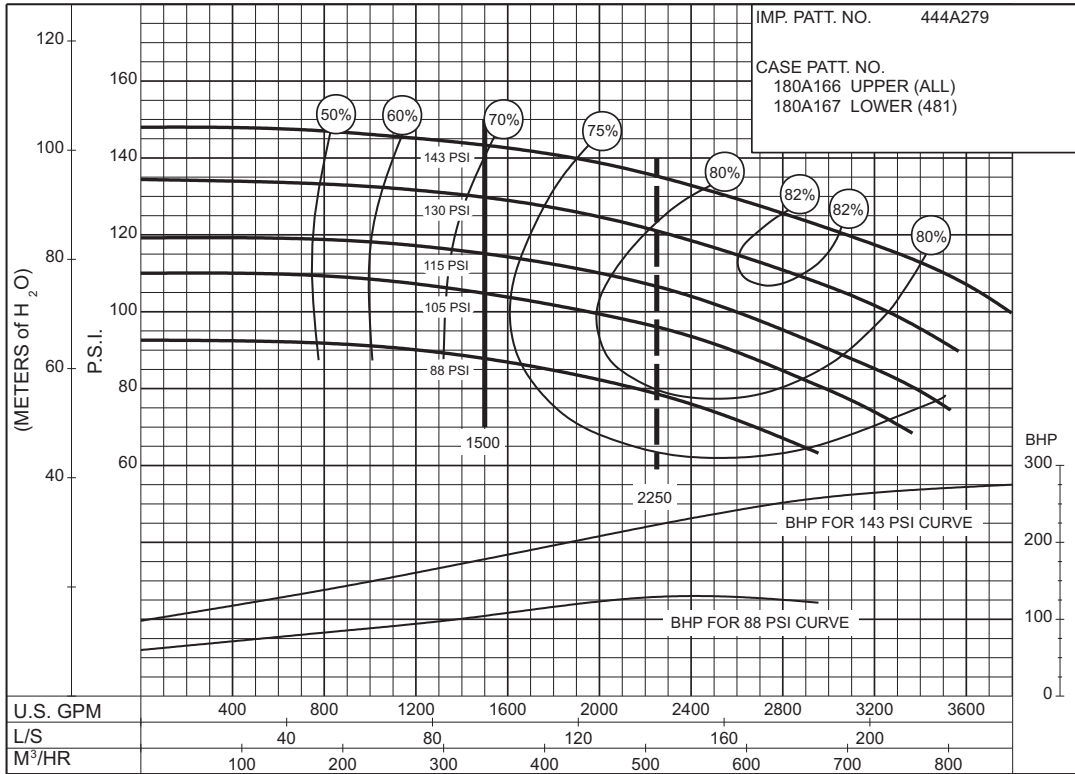

PC-147580A

88
to
143
P.S.I.

2000 G.P.M. 912 SERIES

50 HERTZ ELECTRIC MOTOR DRIVE

SIZE : 8-481-17B / 8-483-17B

MODEL: 480

IMPELLER : Enclosed

R. P. M. : 1480

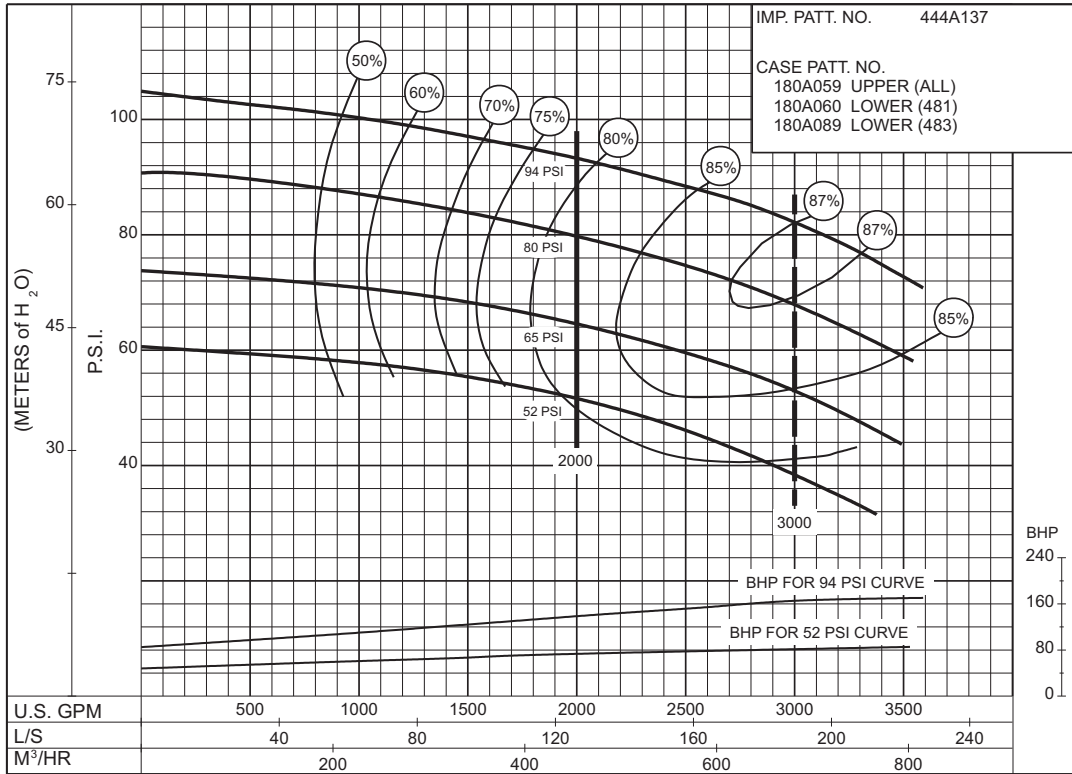

PC-147584A

52 to 94 P.S.I.

SIZE : 8-481-21

MODEL: 480

IMPELLER : Enclosed

R. P. M. : 1480

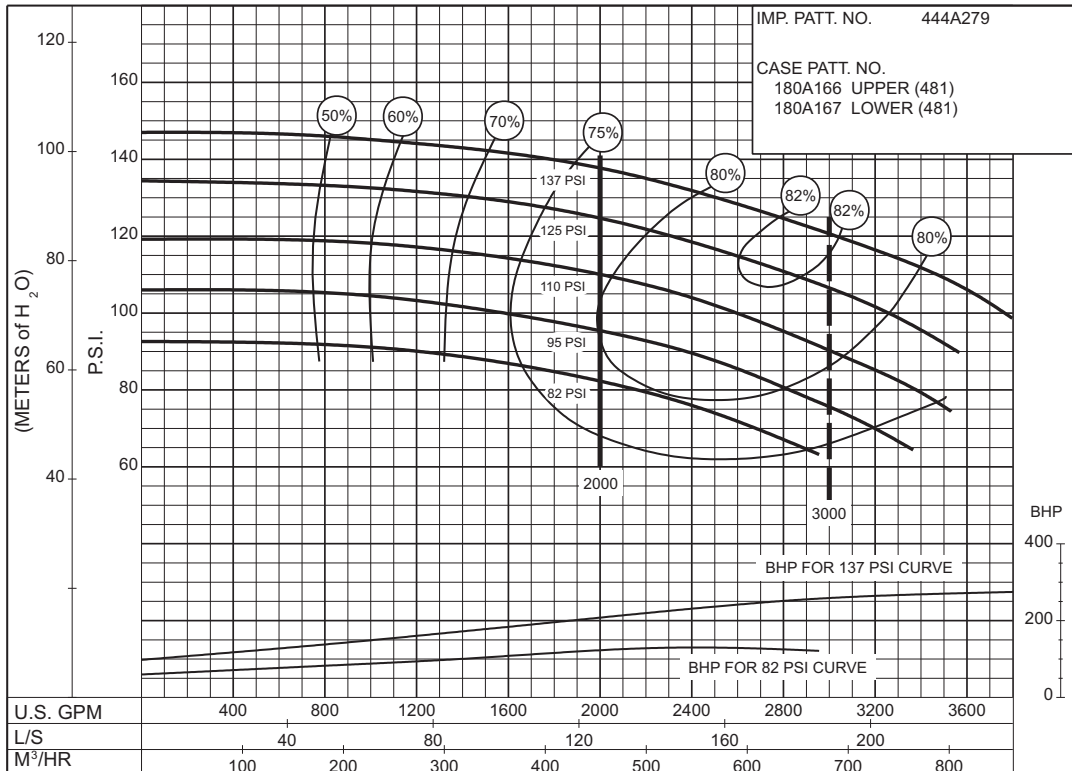

PC-147586A

82 to 137 P.S.I.

2000 G.P.M. 912 SERIES
50 HERTZ ELECTRIC MOTOR DRIVE

SIZE: 8-481-24 MODEL: 480 TYPE : ELECTRIC IMPELLER : Enclosed R. P. M. : 1480

IMP. PATT. NO. 444A797
 CASE PATT. NO. 180A509 UPPER (481)
 180A510 LOWER (481)

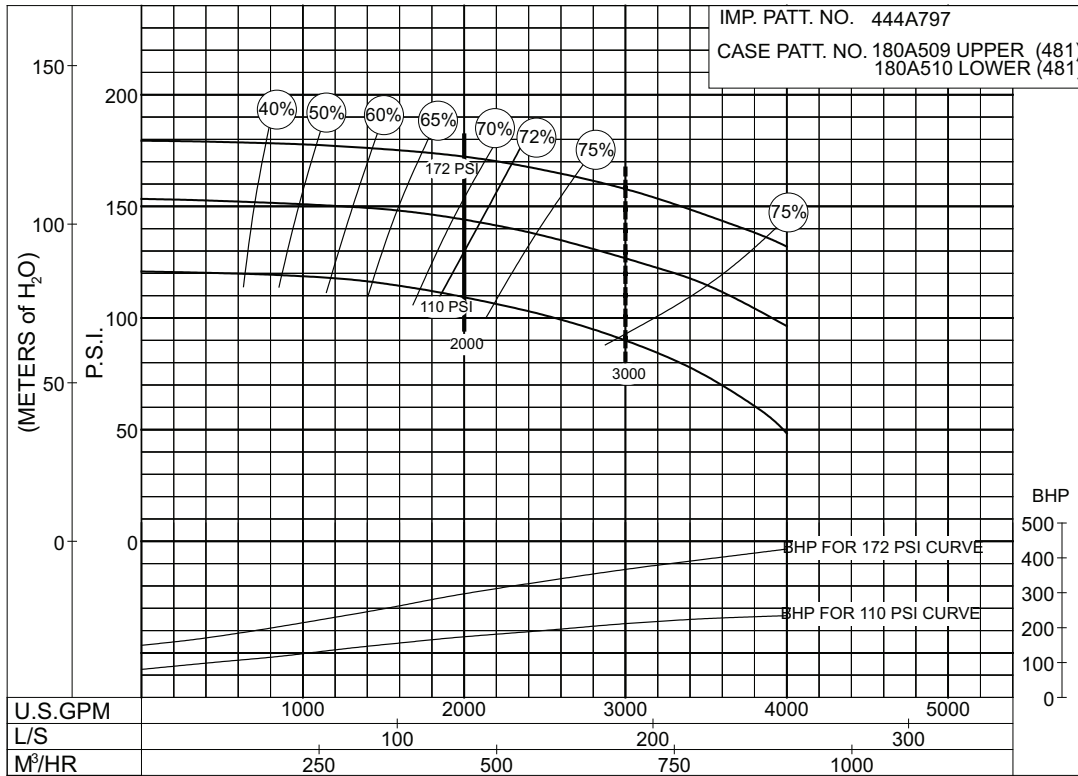

**110
to
172
P.S.I.**

PC- 196149

2500 G.P.M. 912 SERIES

50 HERTZ ELECTRIC MOTOR DRIVE

SIZE : 8-481-21A

MODEL: 480

IMPELLER : Enclosed

R. P. M. : 1480

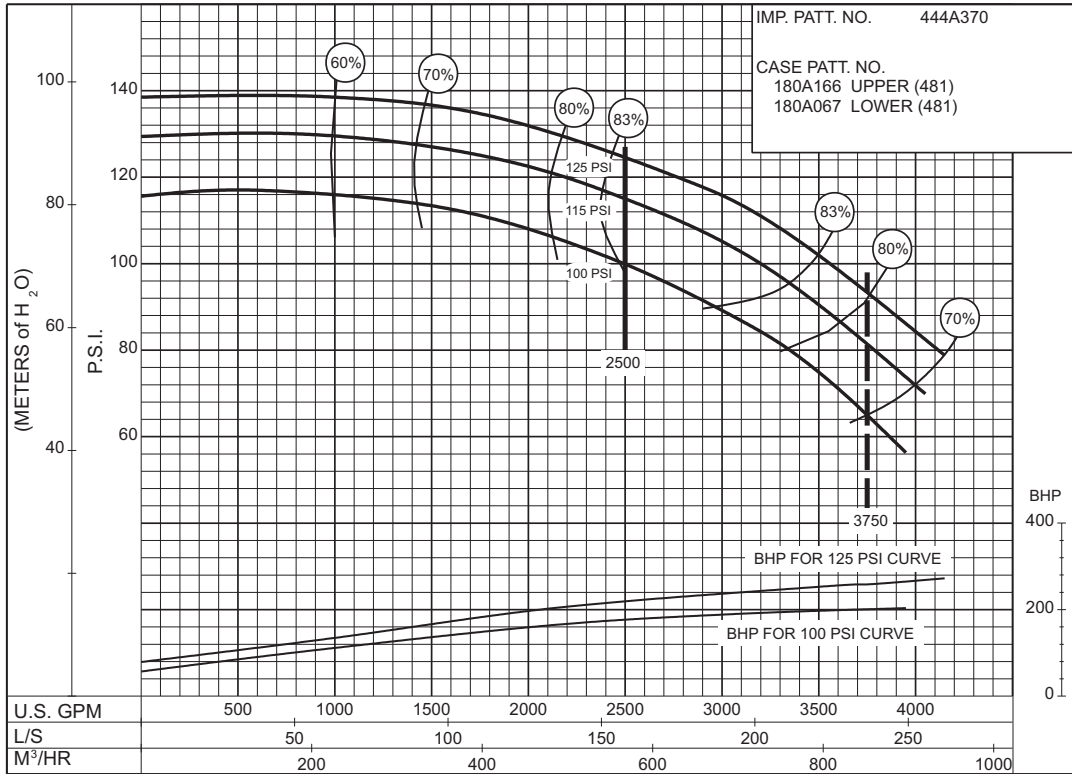

PC-157064

100 to 125 P.S.I.

SIZE: 8-481-24

MODEL: 480

TYPE : ELECTRIC

IMPELLER : Enclosed

R. P. M. : 1480

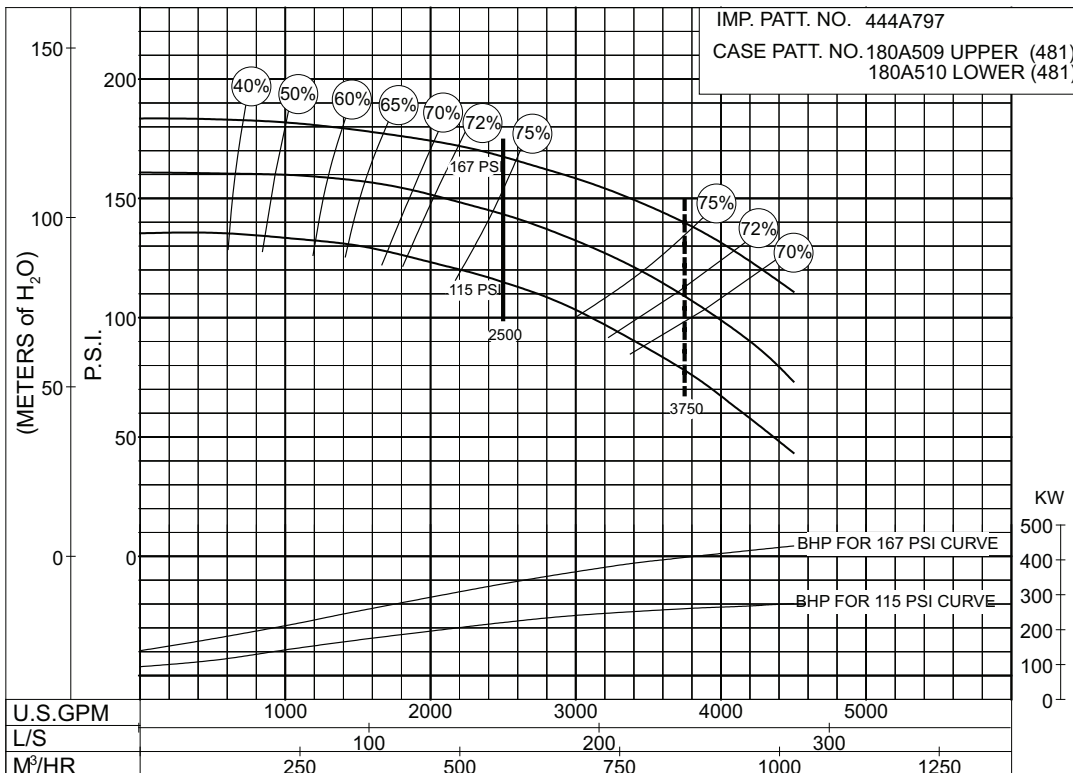

PC-196153

115 to 167 P.S.I.



AURORA®

2500 G.P.M. 912 SERIES 50 HERTZ ELECTRIC MOTOR DRIVE

SIZE : 10-481-18

MODEL: 480

IMPELLER : Enclosed

R. P. M. : 1480

IMP. PATT. NO. 444A146

CASE PATT. NO.
180A223 UPPER (481)
180A224 LOWER (481)

65
to
101
P.S.I.

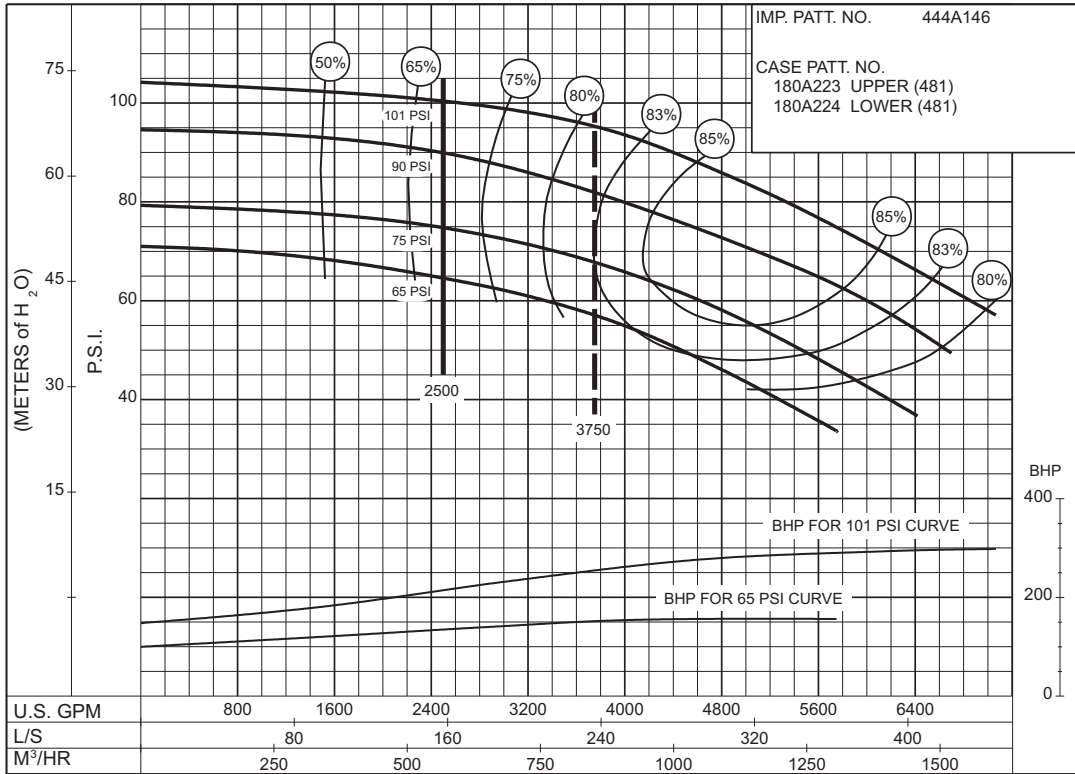

PC-147588A

THIS PAGE LEFT INTENTIONALLY BLANK

2500 G.P.M. 912 SERIES
50 HERTZ ELECTRIC MOTOR DRIVE

**63
to
96
P.S.I.**

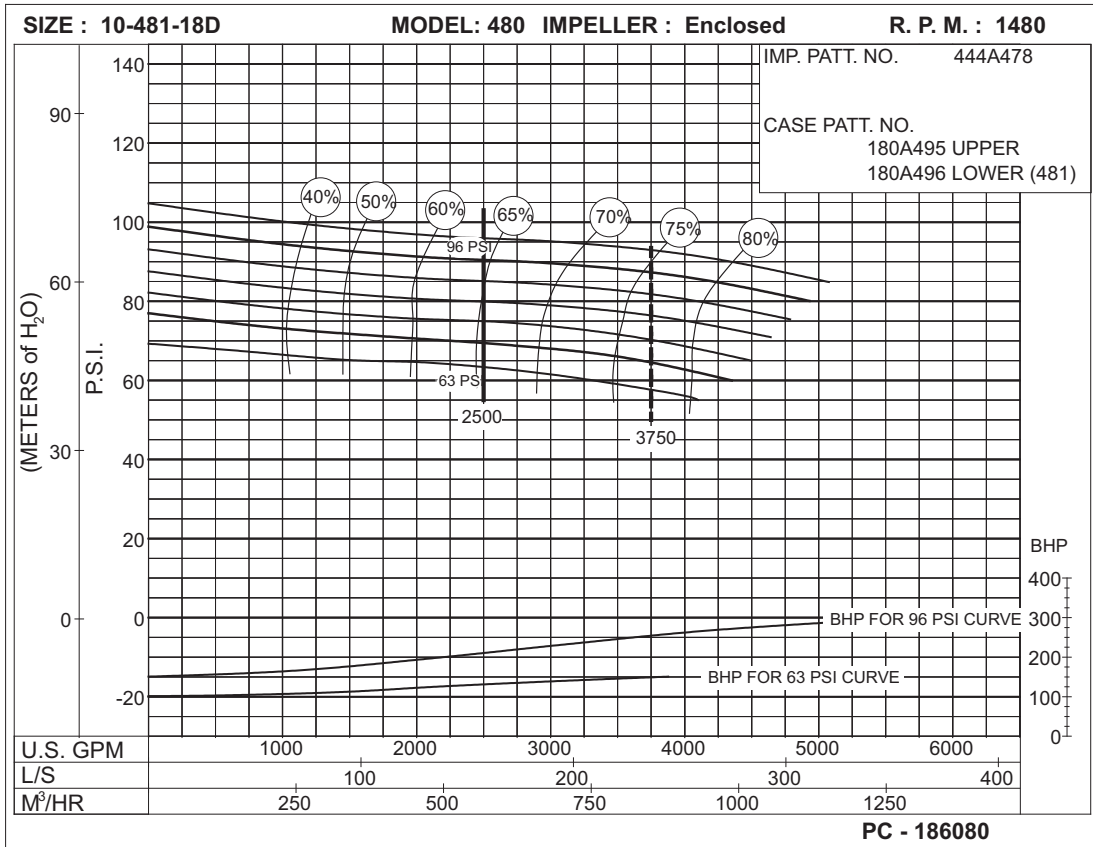

**100
to
171
P.S.I.**

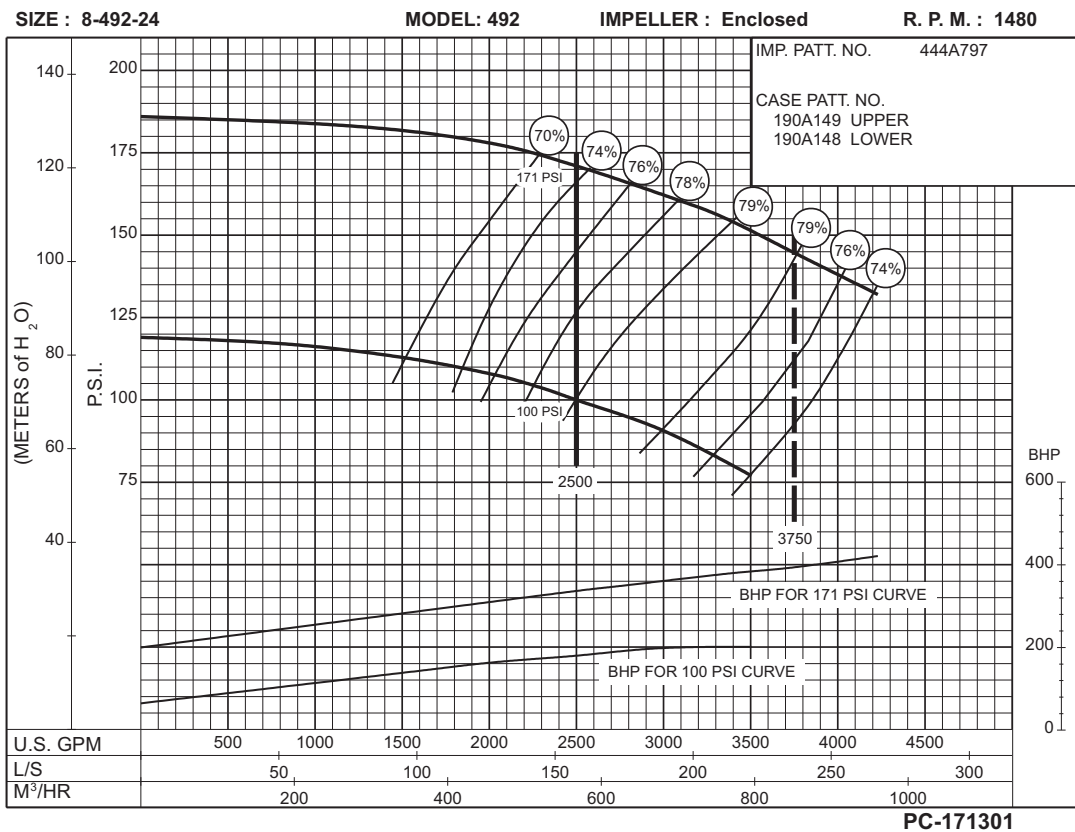

3000 G.P.M. 912 SERIES

50 HERTZ ELECTRIC MOTOR DRIVE

SIZE : 10-481-18

MODEL: 480

IMPELLER : Enclosed

R. P. M. : 1480

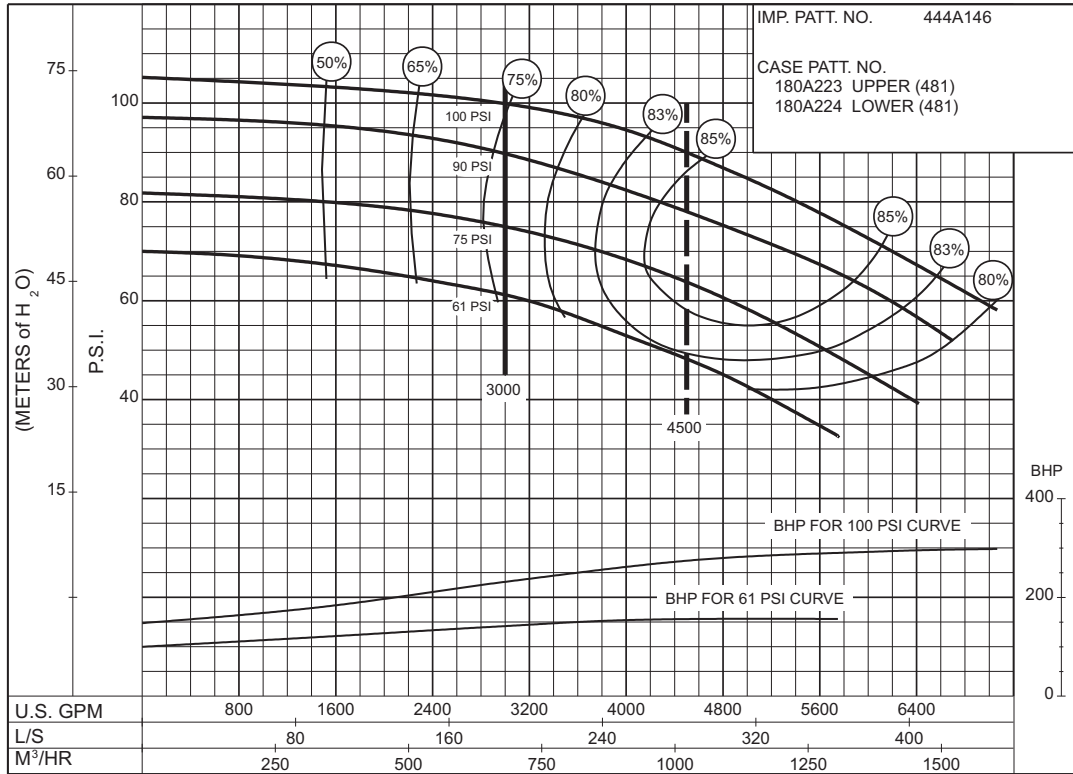

61 to 100 P.S.I.

SIZE : 10-481-18D

MODEL: 480 IMPELLER : Enclosed

R. P. M. : 1480

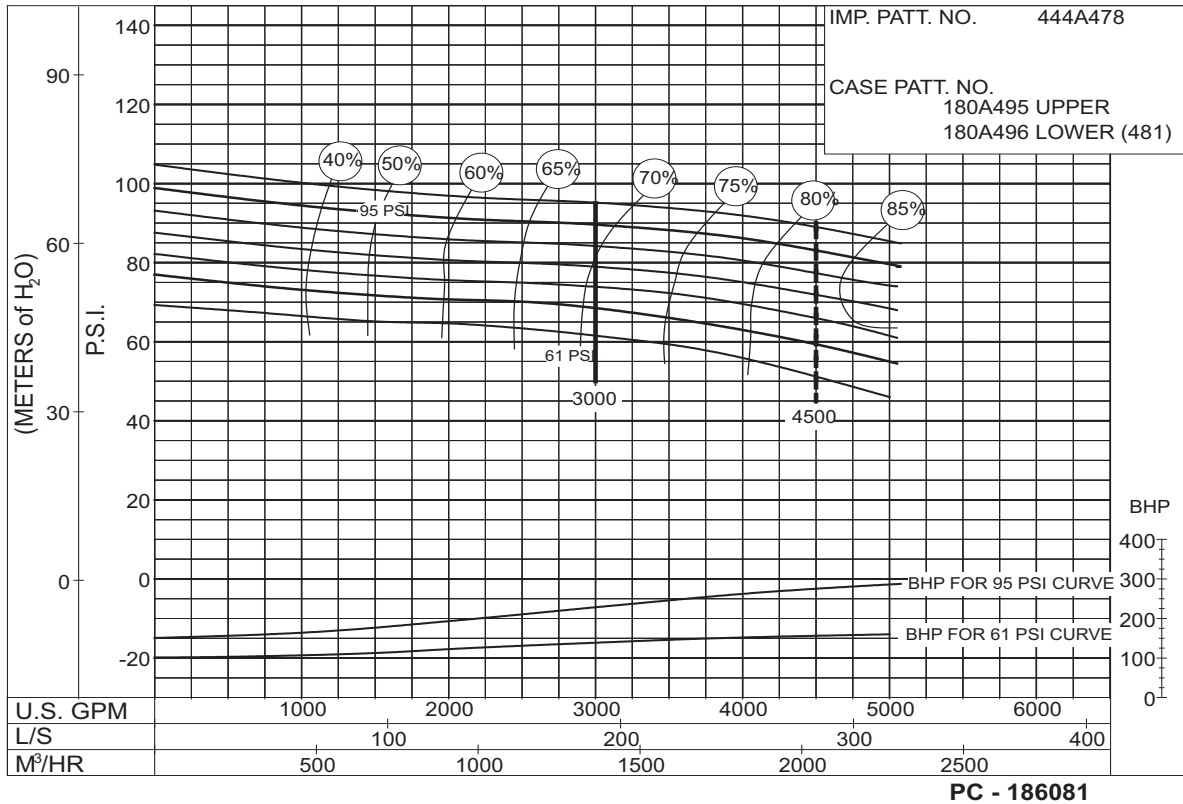

61 to 95 P.S.I.

Section **912** Page **620**

Date **April 2000**

Supersedes Section 912 Page 620

THIS PAGE LEFT INTENTIONALLY BLANK

3500 G.P.M. 912 SERIES

50 HERTZ ELECTRIC MOTOR DRIVE

SIZE : 10-481-18

MODEL: 480

IMPELLER : Enclosed

R. P. M. : 1480

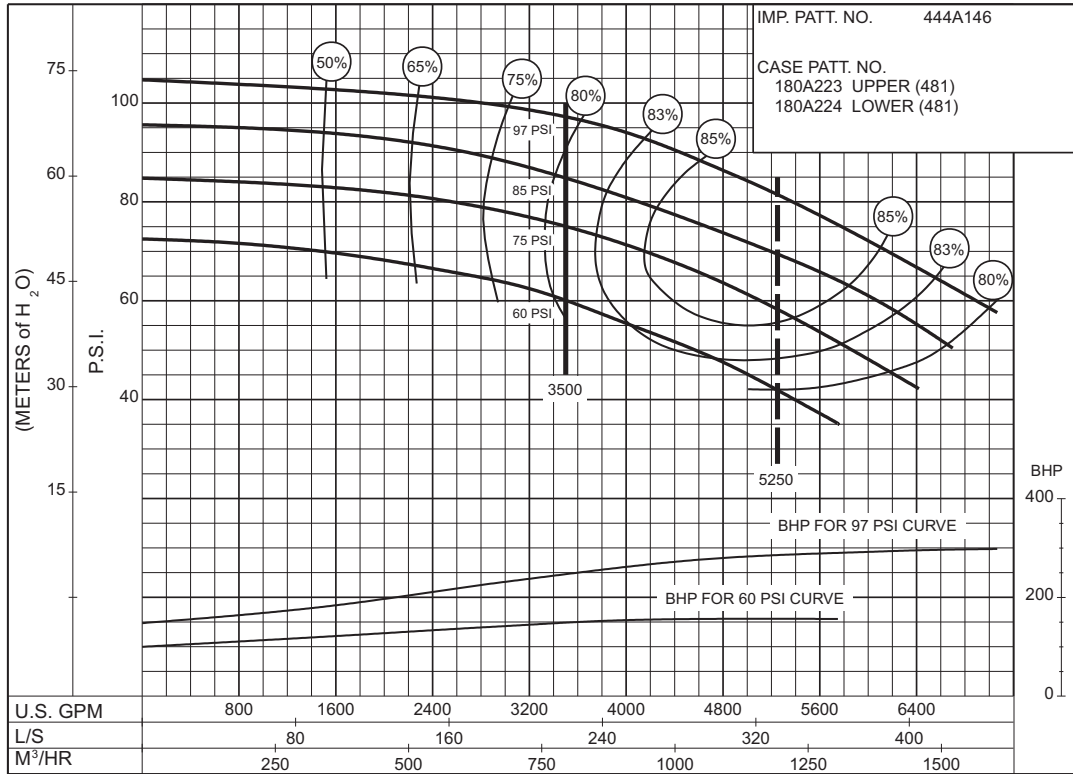

PC-147592A

60 to 97 P.S.I.

SIZE : 10-481-18D

MODEL: 480 IMPELLER : Enclosed

R. P. M. : 1480

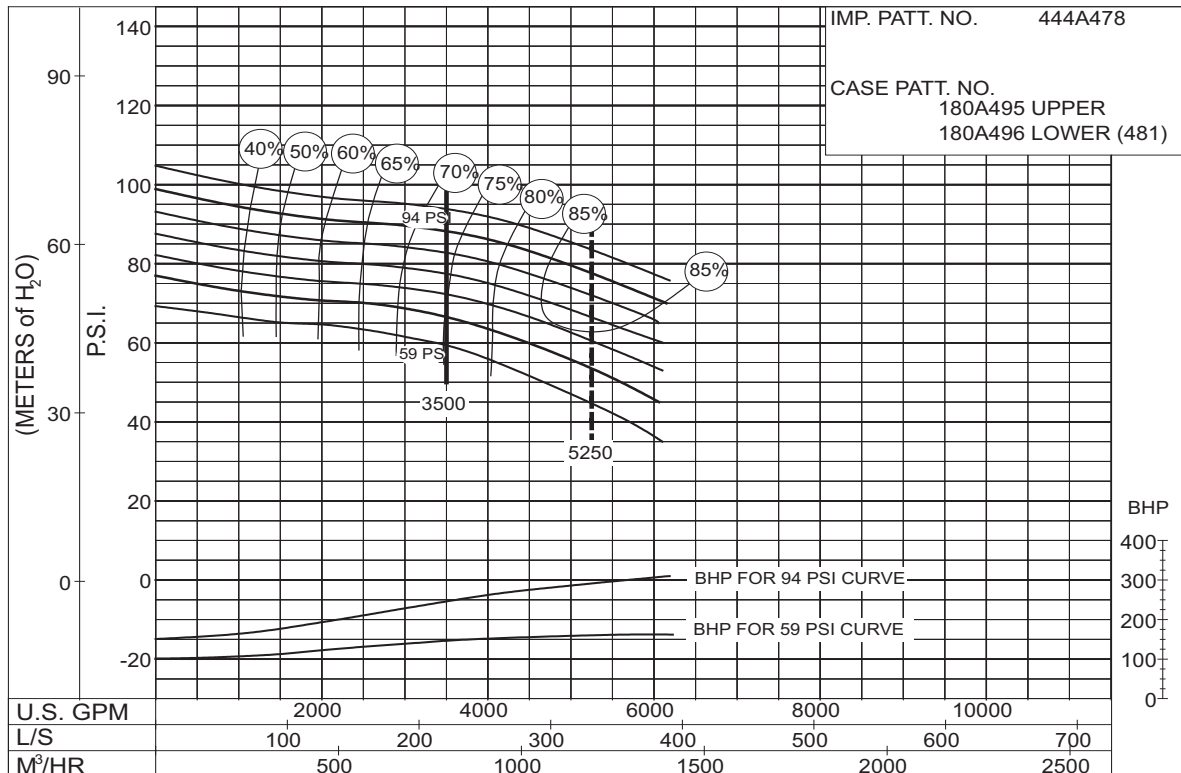

PC - 186082

59 to 94 P.S.I.



AURORA®

Section **912** Page **622**

Date **April 2000**

Supersedes Section 912 Page 622

THIS PAGE LEFT INTENTIONALLY BLANK

4000 G.P.M. 912 SERIES
50 HERTZ ELECTRIC MOTOR DRIVE

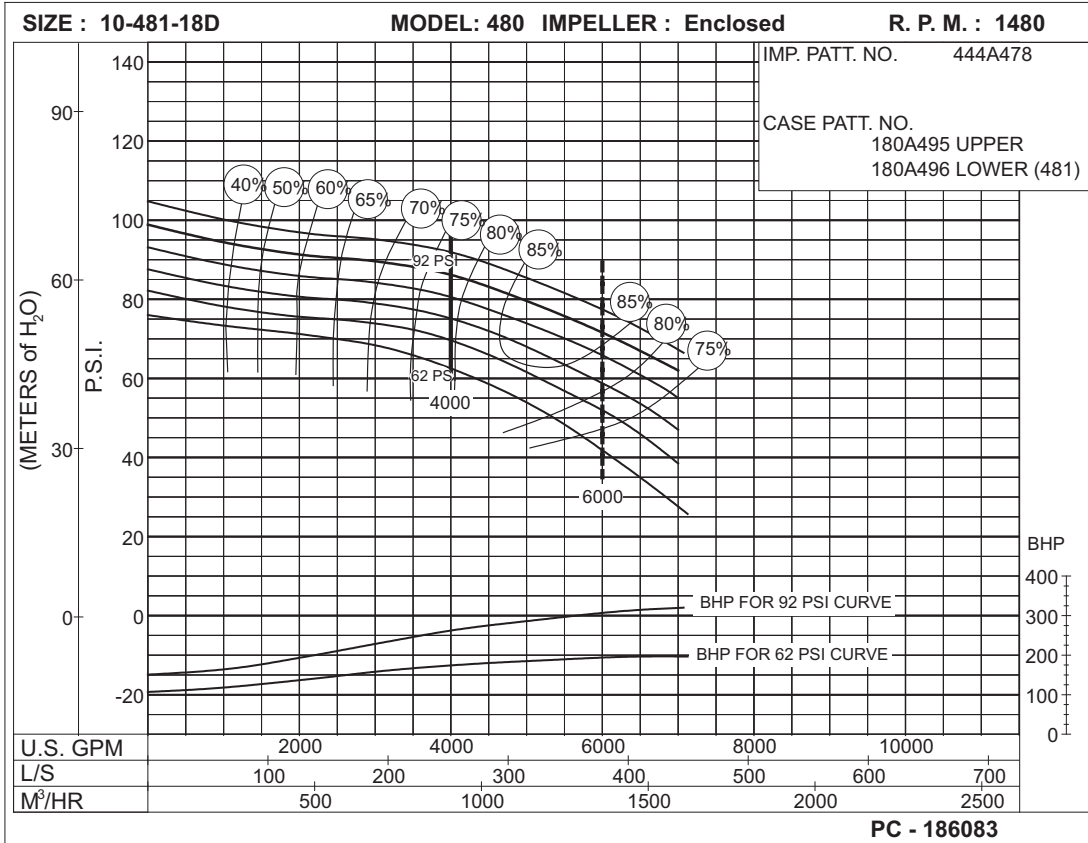

**62
to
92
P.S.I.**

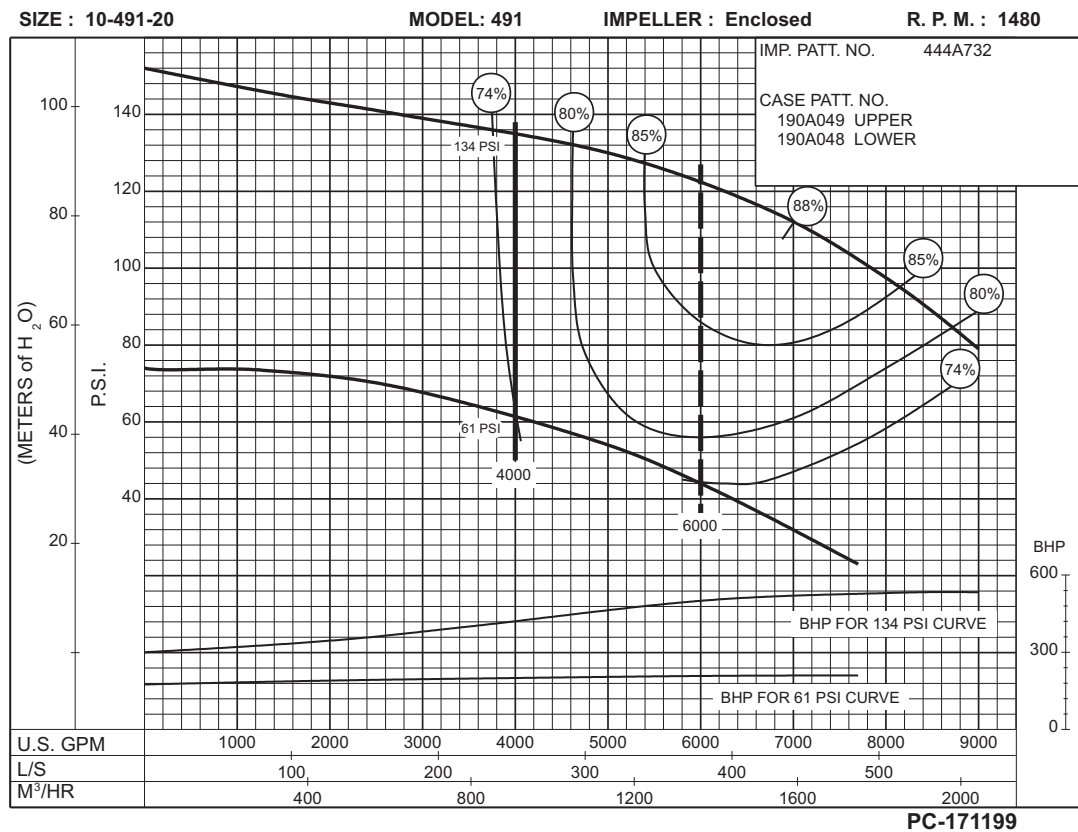

**61
to
134
P.S.I.**



AURORA®

4000 G.P.M. 912 SERIES
 50 HERTZ ELECTRIC MOTOR DRIVE

Supersedes Section 912 Page 624
 Dated April 2000

SIZE : 12-481-18A MODEL: 480 IMPELLER : Enclosed R. P. M. : 1480

IMP. PATT. NO. 444A292
 CASE PATT. NO.
 180A227 UPPER (481)
 180A228 LOWER (481)

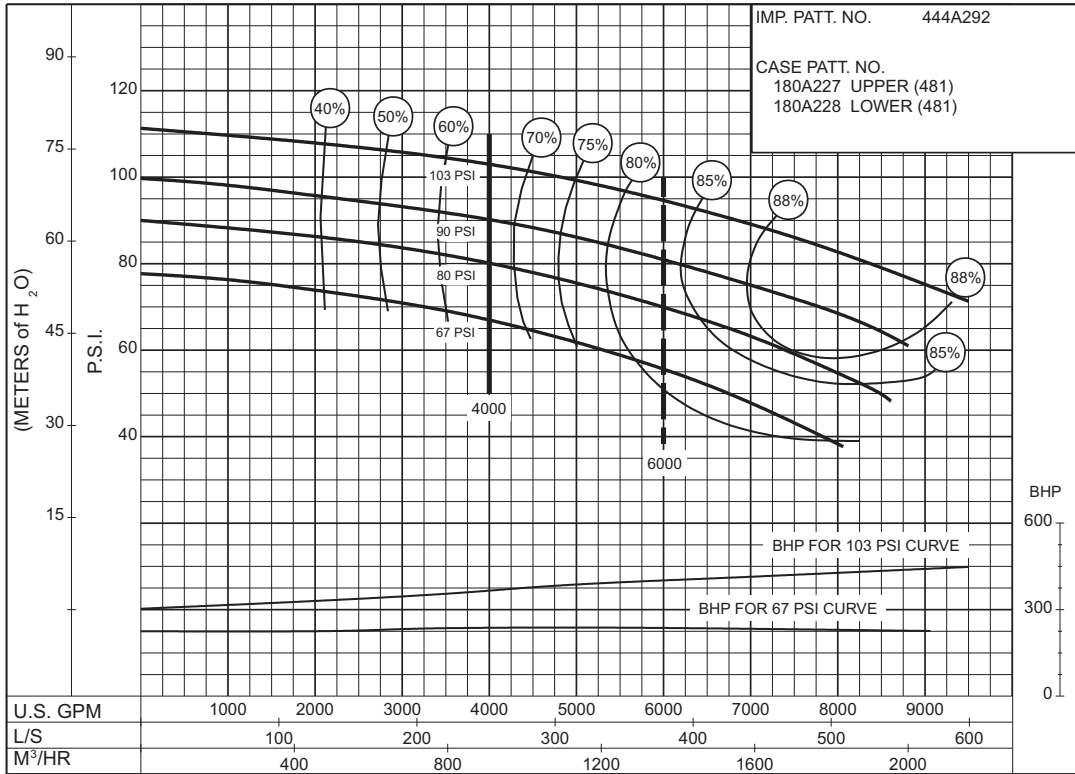

**67
to
103
P.S.I.**

PC-147594A

4500 G.P.M. 912 SERIES

50 HERTZ ELECTRIC MOTOR DRIVE

Section **912** Page **625**

Date **April 2000**

Supersedes Section 912 Page 625

Dated August 1992

SIZE : 10-491-20

MODEL: 491

IMPELLER : Enclosed

R. P. M. : 1480

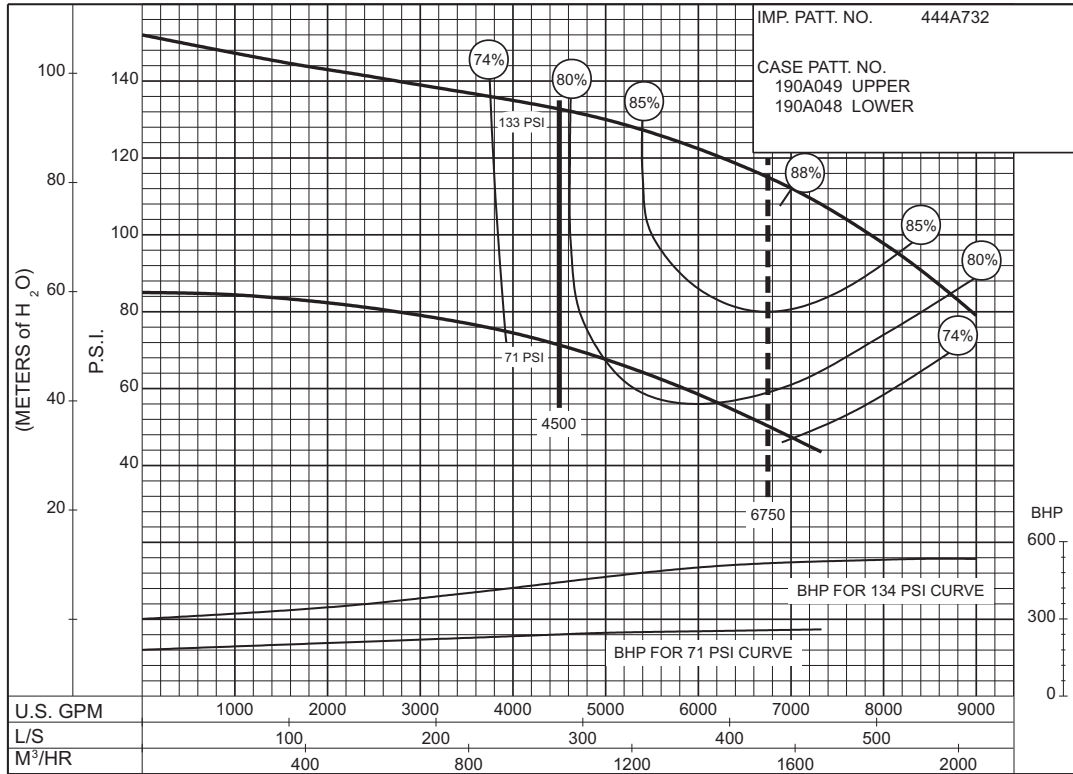

71
to
133
P.S.I.

PC-171200

Section **912** Page **626**

Date **April 2000**

Supersedes Section 912 Page 626

THIS PAGE LEFT INTENTIONALLY BLANK

5000 G.P.M. 912 SERIES

50 HERTZ ELECTRIC MOTOR DRIVE

Section **912** Page **627**

Date **April 2000**

Supersedes Section 912 Page 627

Dated August 1992

SIZE : 10-491-20

MODEL: 491

IMPELLER : Enclosed

R. P. M. : 1480

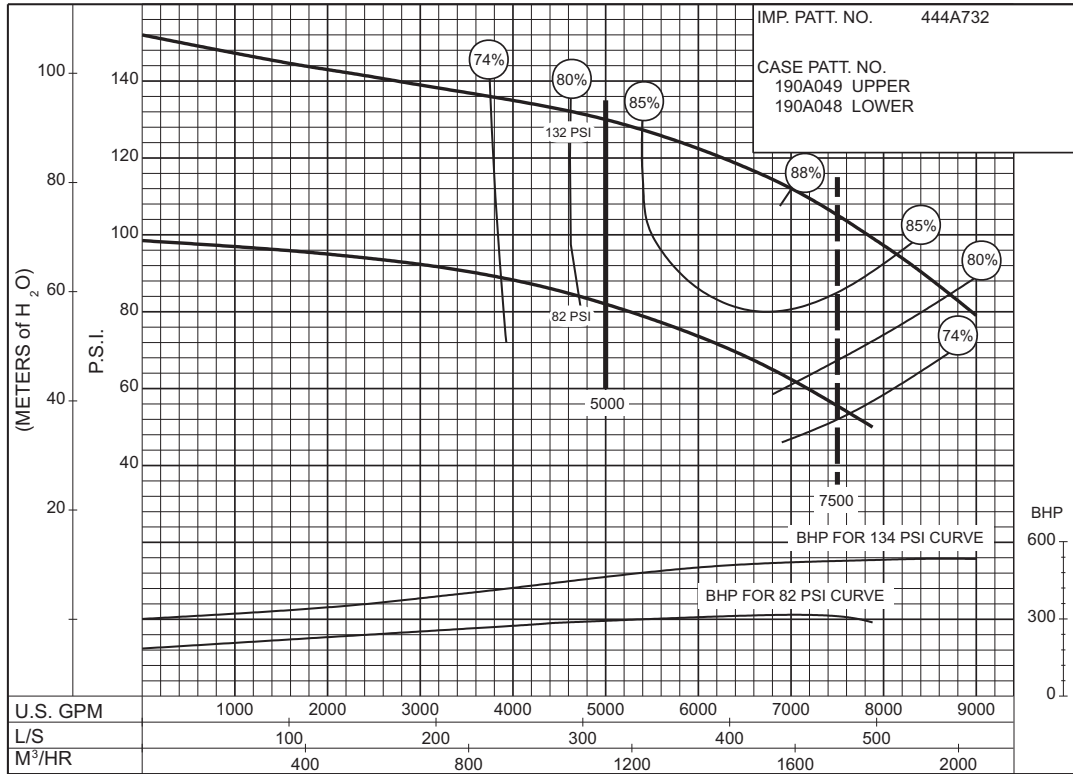

82
to
132
P.S.I.

PC-171201

Section **912** Page **628**

Date **April 2000**

Supersedes Section 912 Page 628

THIS PAGE LEFT INTENTIONALLY BLANK